

**THE BOOK OF JAMES**  
***Life Instruction Manual***

**2263** ***Manual de Instrucciones***

***Manuel d'Instruction***

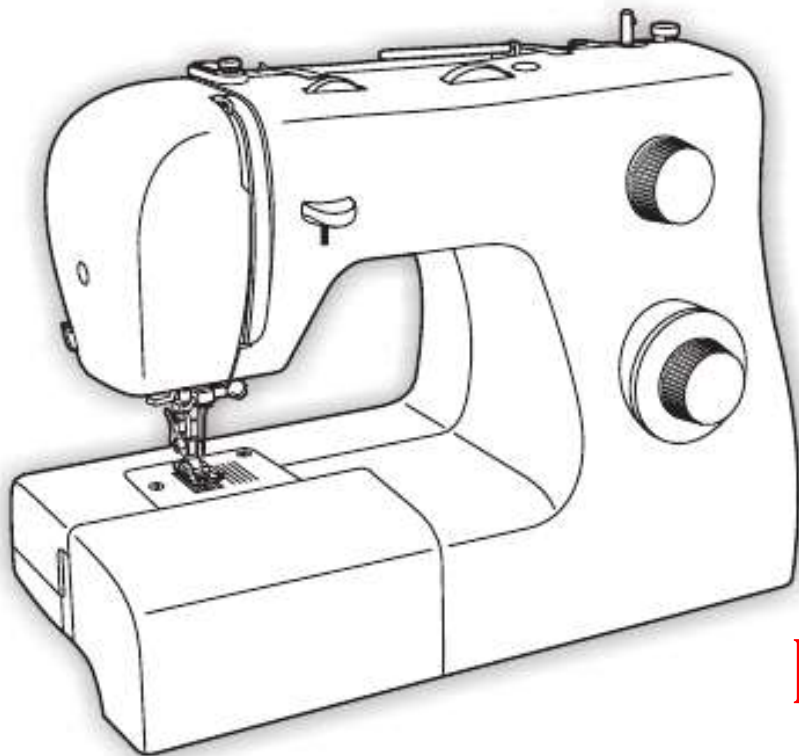

**END THE WAR**

***James 4:1-10***

---

**2263** *Manual de Instrucciones*

---

*Manuel d'Instruction*

## James 4:1-10

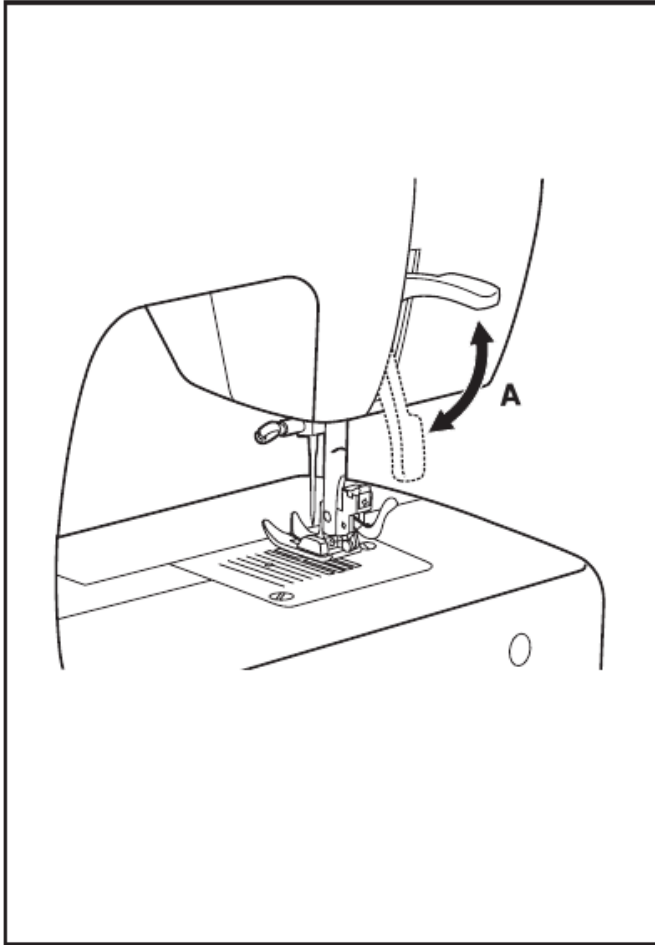

What causes fights and quarrels among you? Don't they come from your desires that battle within you? <sup>2</sup> You want something but don't get it. You kill and covet, but you cannot have what you want. You quarrel and fight. You do not have, because you do not ask God. <sup>3</sup> When you ask, you do not receive, because you ask with wrong motives, that you may spend what you get on your pleasures.

## James 4:1-10

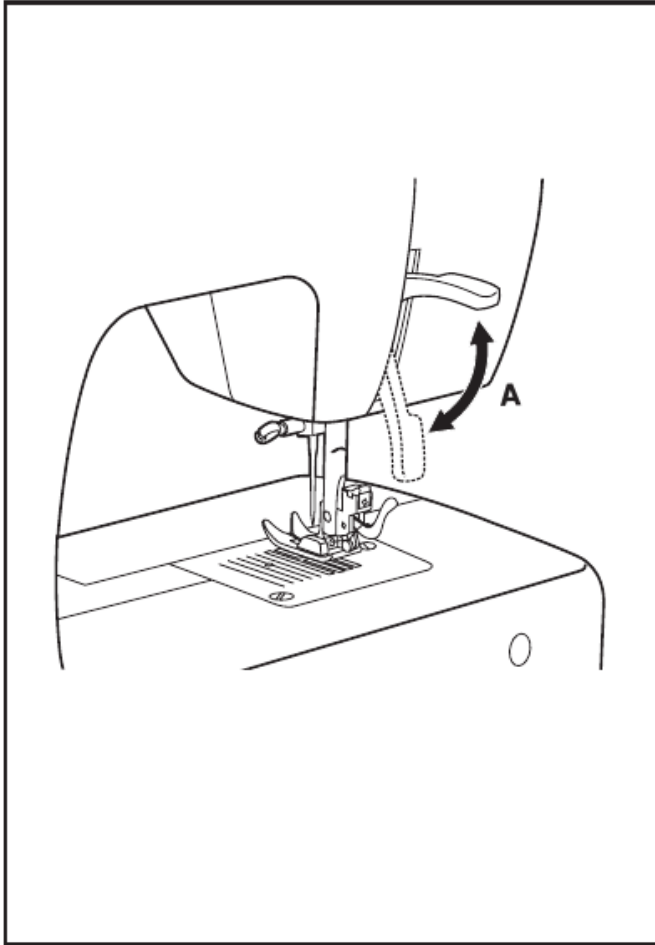

<sup>4</sup> You adulterous people, don't you know that friendship with the world is hatred toward God? Anyone who chooses to be a friend of the world becomes an enemy of God. <sup>5</sup> Or do you think Scripture says without reason that the spirit he caused to live in us envies intensely? <sup>6</sup> But he gives us more grace. That is why Scripture says: "God opposes the proud but gives grace to the humble."

## James 4:1-10

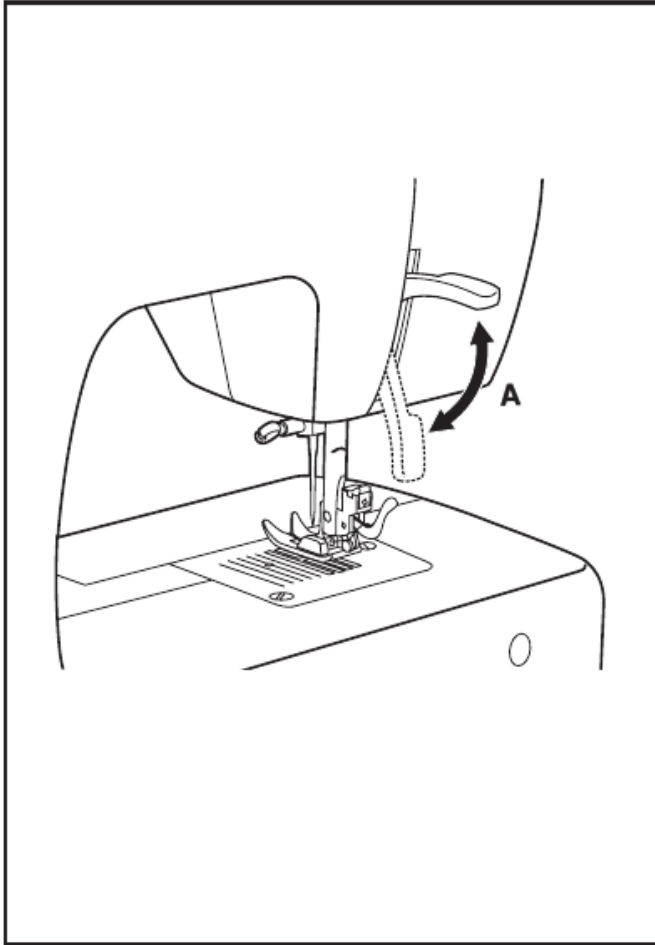

<sup>7</sup> Submit yourselves, then, to God. Resist the devil, and he will flee from you.<sup>8</sup> Come near to God and he will come near to you. Wash your hands, you sinners, and purify your hearts, you double-minded. <sup>9</sup> Grieve, mourn and wail. Change your laughter to mourning and your joy to gloom. <sup>10</sup> Humble yourselves before the Lord, and he will lift you up.

## Christ of the Andes



**James 4:1-3**

<sup>1</sup>What causes fights and quarrels among you? Don't they come from your desires that battle within you? <sup>2</sup> You want something but don't get it. You kill and covet, but you cannot have what you want. You quarrel and fight. You do not have, because you do not ask God. <sup>3</sup> When you ask, you do not receive, because you ask with wrong motives, that you may spend what you get on your pleasures.

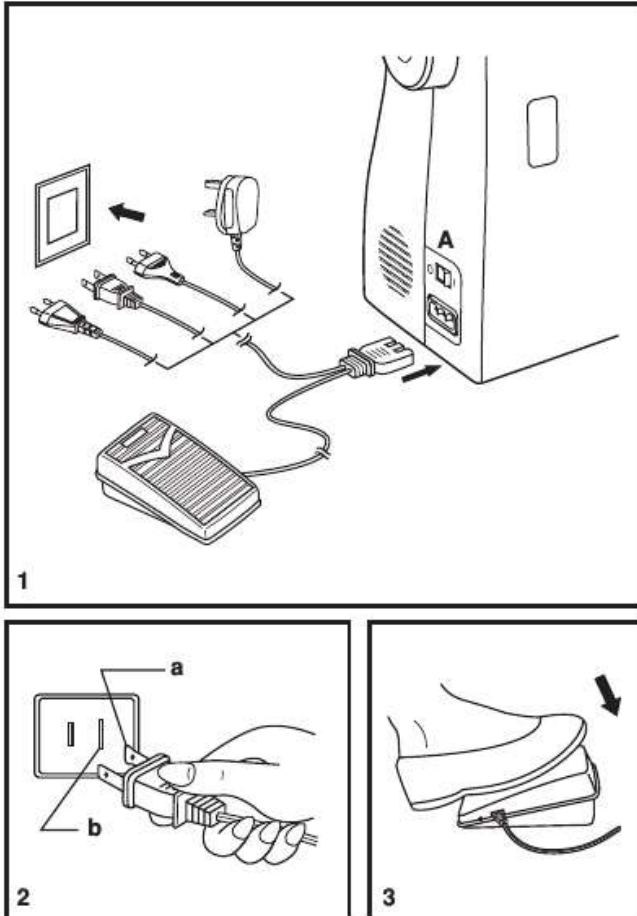

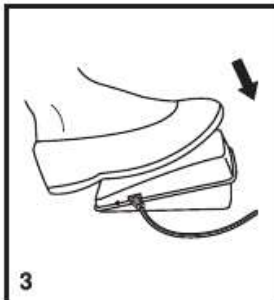
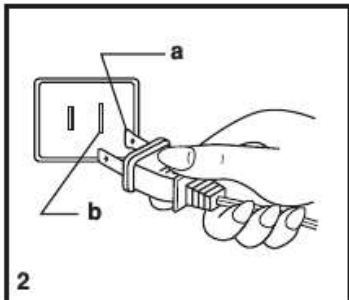
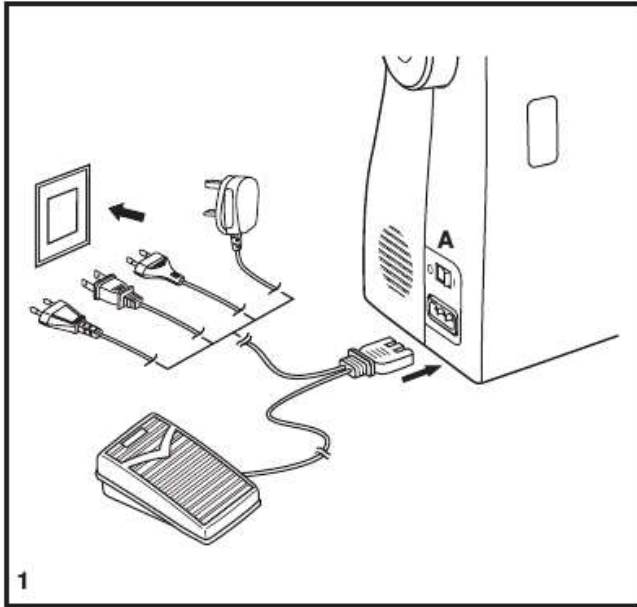

***ATTENTION:***  
***The cause of conflict is***  
***conflicting desires.***



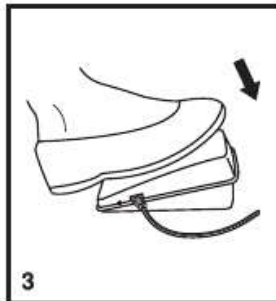
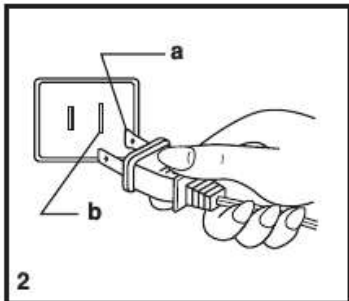
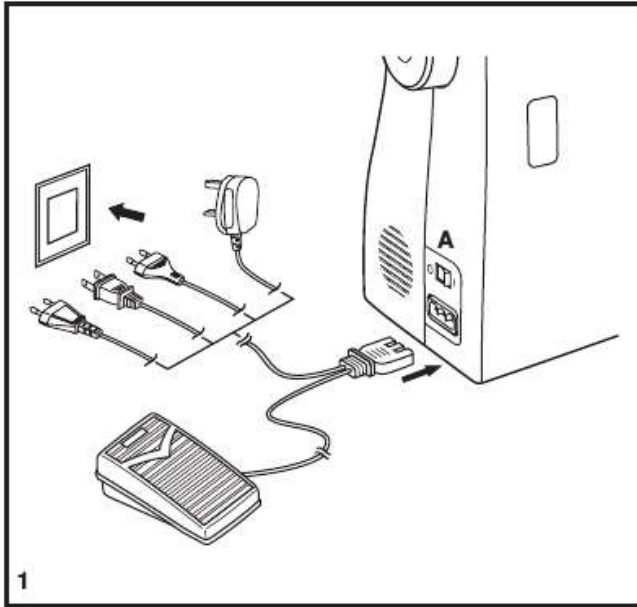

## Covet

### *Matthew 5:28*

But I say, anyone who even looks at a woman with lust has already committed adultery with her in his heart.

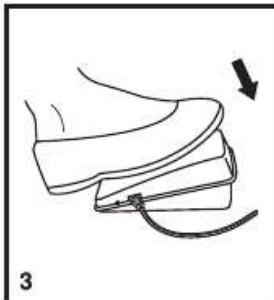
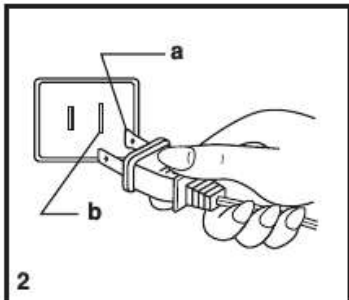
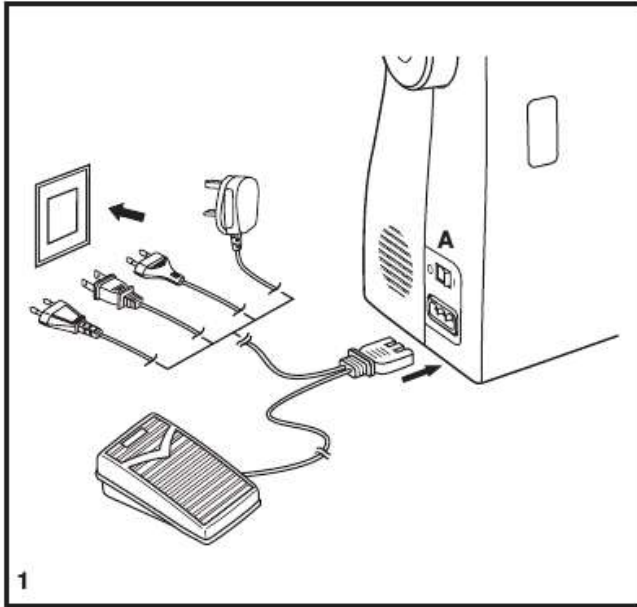

## ***Covet***

### ***Luke 22:15***

Jesus said, "I have been very eager to eat this Passover meal with you before my suffering begins."

## Covet

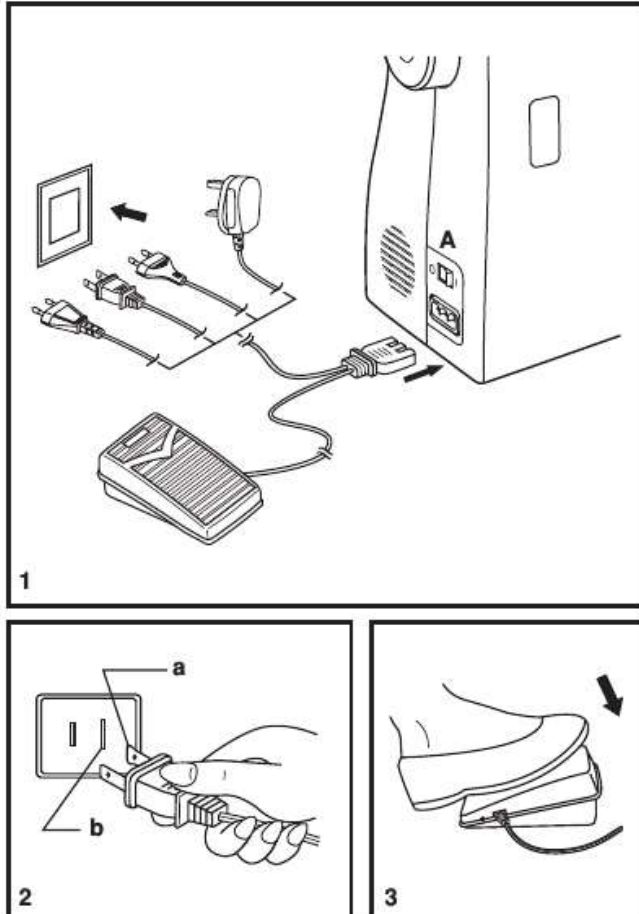

**ATTENTION:**  
*The problem with covetousness is when it leads us to do whatever we must to get what we want, whether the thing is good or bad.*

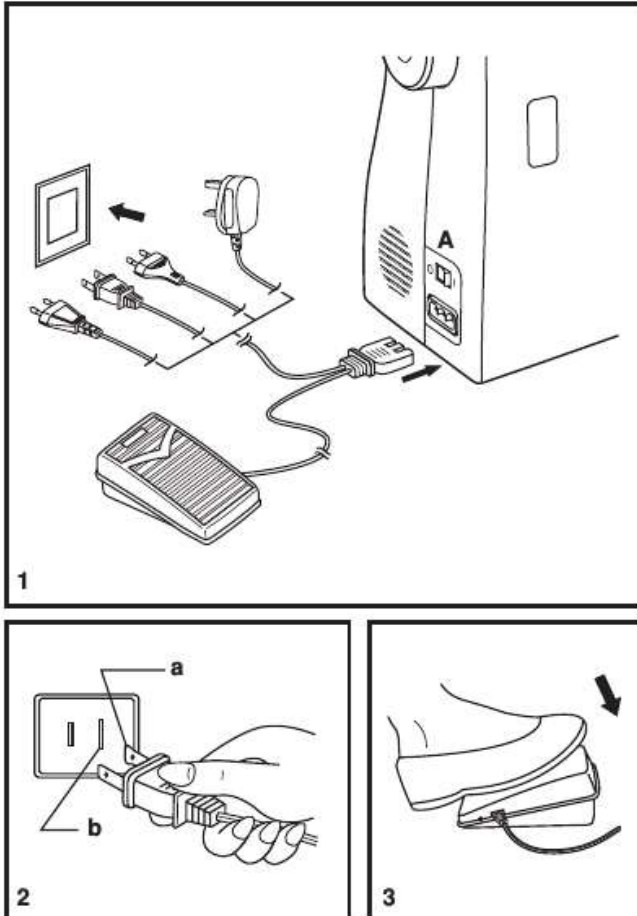

## *Godlessness*

### *James 4:2*

You want something but don't get it. You kill and covet, but you cannot have what you want. You quarrel and fight. You do not have, because you do not ask God.

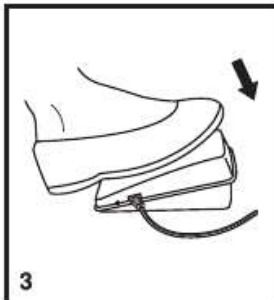
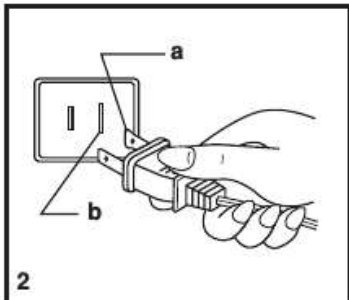
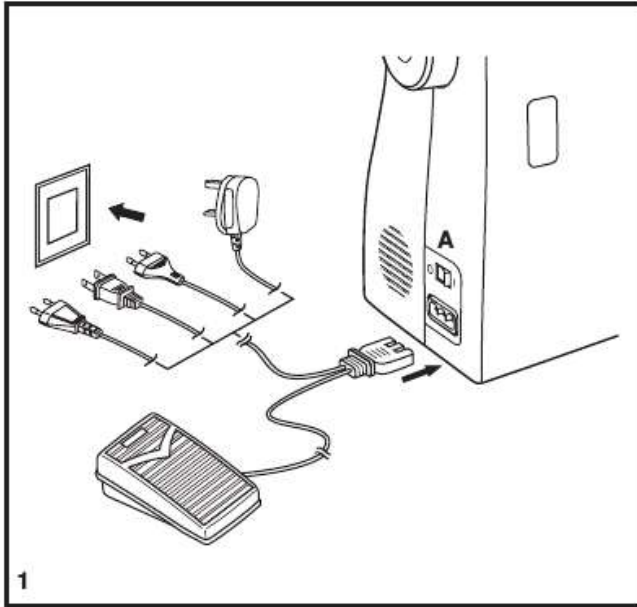

## *Godlessness*

### *Luke 22:42*

“Father, if you are willing, take this cup from me; yet not my will, but yours be done.”

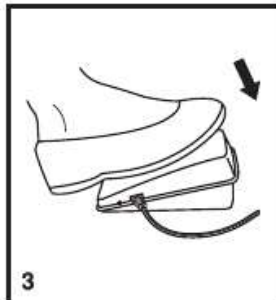
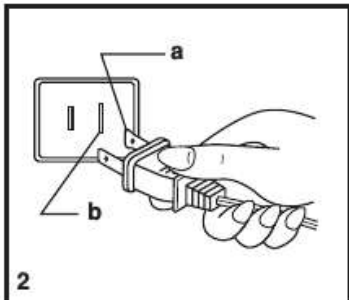
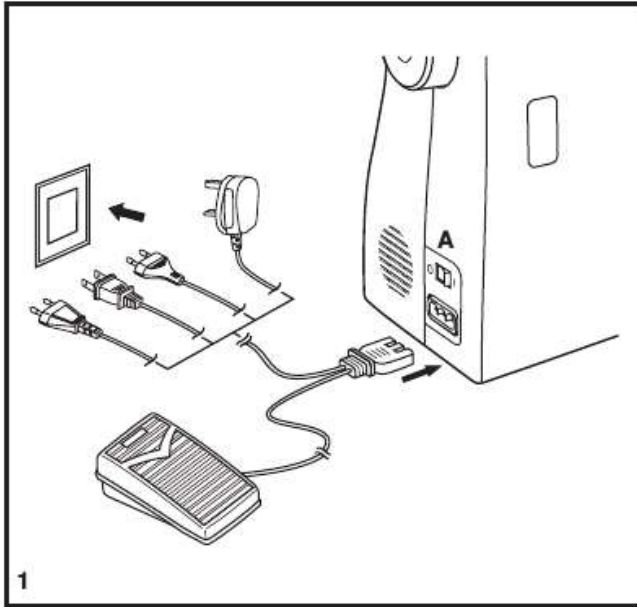

## *Adultery*

***ATTENTION:***  
***Our conflict comes from***  
***our desires that battle with***  
***us.***

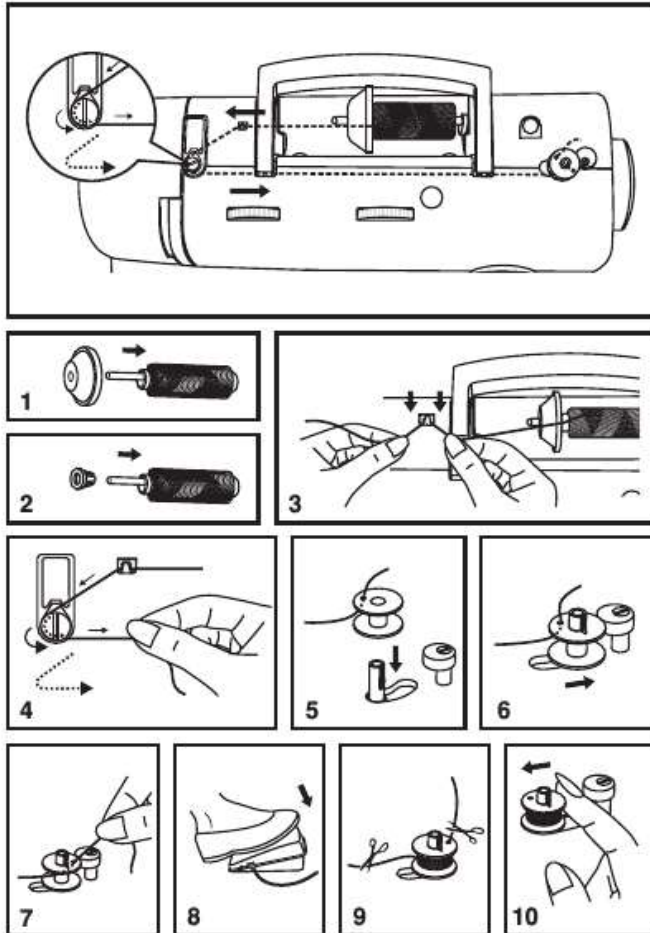

***“Unfortunately, recognizing your faults and actually changing your ways are two different things.”***

*We must submit to God*

**James 4:7**

Submit yourselves, then, to God.

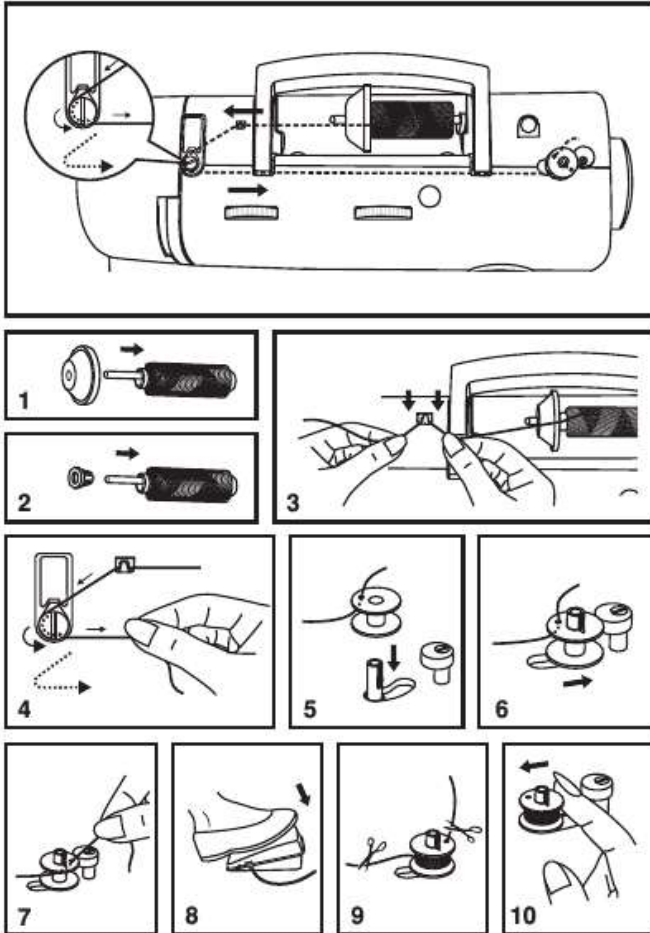



*We must submit to God*

**ATTENTION:**

*If we have put God in charge of our lives and we are living in submission to Him, then His peace will rule our lives.*

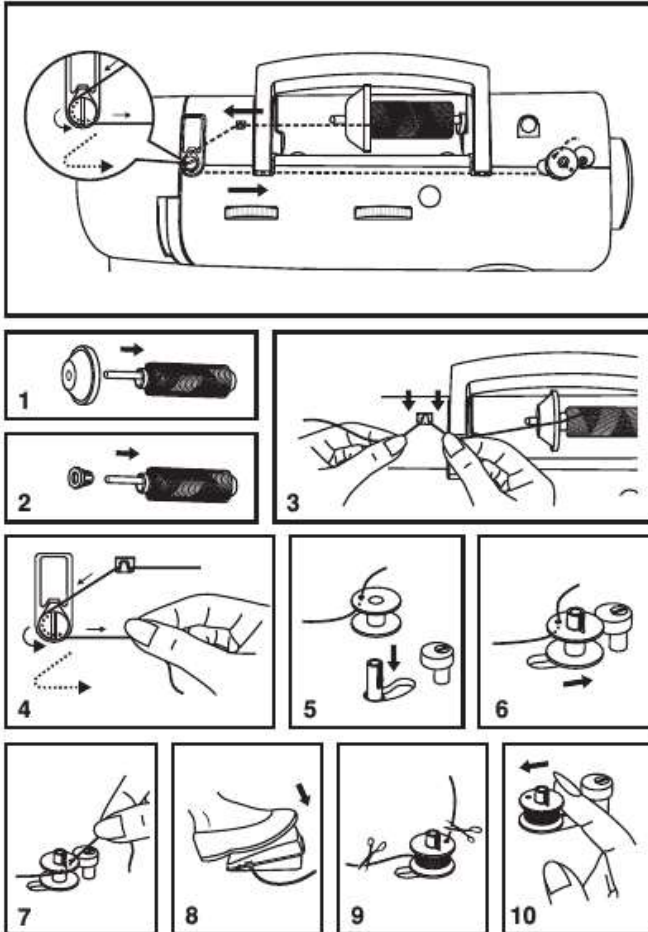

*We must resist the devil*

**James 4:7**

Resist the devil, and he will flee from you.

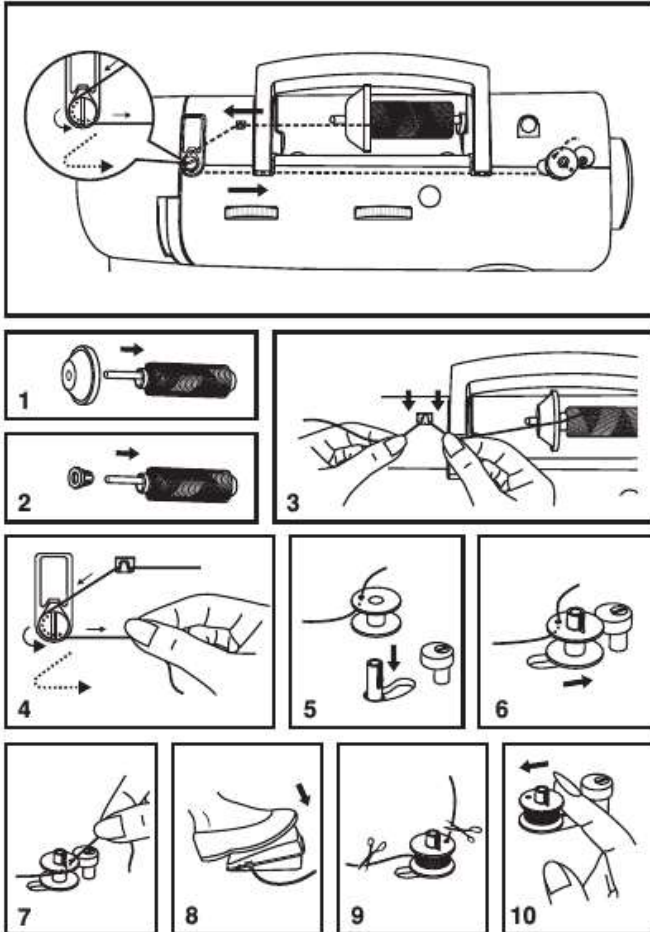

## *We must resist the devil*

### *Ephesians 6:10-18*

Finally, be strong in the Lord and in his mighty power.<sup>11</sup> Put on the full armor of God so that you can take your stand against the devil's schemes. <sup>12</sup> For our struggle is not against flesh and blood, but against the rulers, against the authorities, against the powers of this dark world and against the spiritual forces of evil in the heavenly realms. <sup>13</sup> Therefore put on the full armor of God, so that

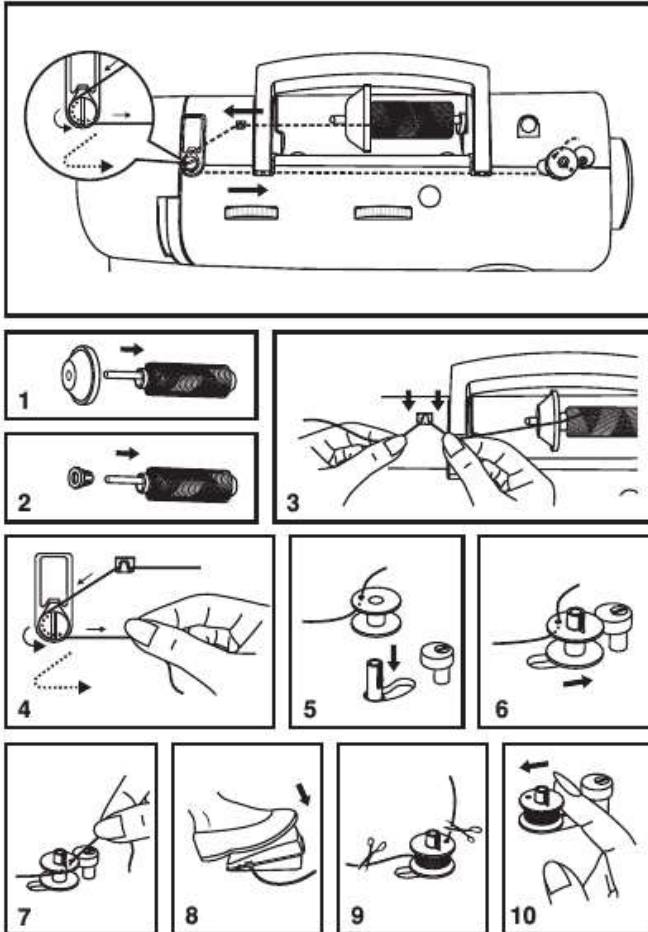

## *We must resist the devil*

### *Ephesians 6:10-18*

when the day of evil comes, you may be able to stand your ground, and after you have done everything, to stand. <sup>14</sup> Stand firm then, with the belt of truth buckled around your waist, with the breastplate of righteousness in place, <sup>15</sup> and with your feet fitted with the readiness that comes from the gospel of peace. <sup>16</sup> In addition to all this, take up the shield of faith, with which you can

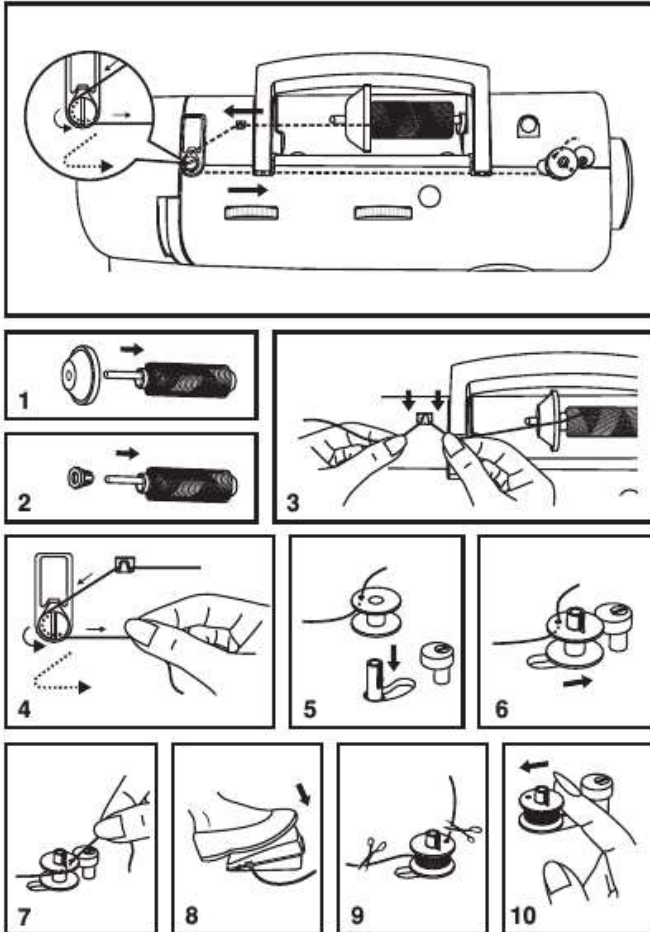

## *We must resist the devil*

### *Ephesians 6:10-18*

extinguish all the flaming arrows of the evil one. <sup>17</sup> Take the helmet of salvation and the sword of the Spirit, which is the word of God. <sup>18</sup> And pray in the Spirit on all occasions with all kinds of prayers and requests. With this in mind, be alert and always keep on praying for all the saints.

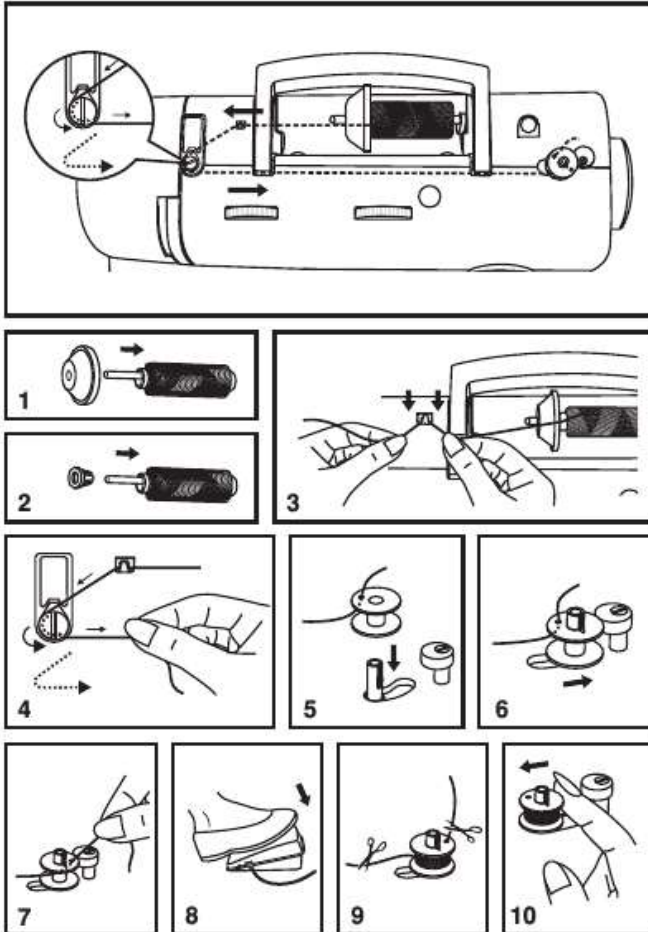

*We must come close to  
God*

*James 4:8*

Come near to God and he  
will come near to you.

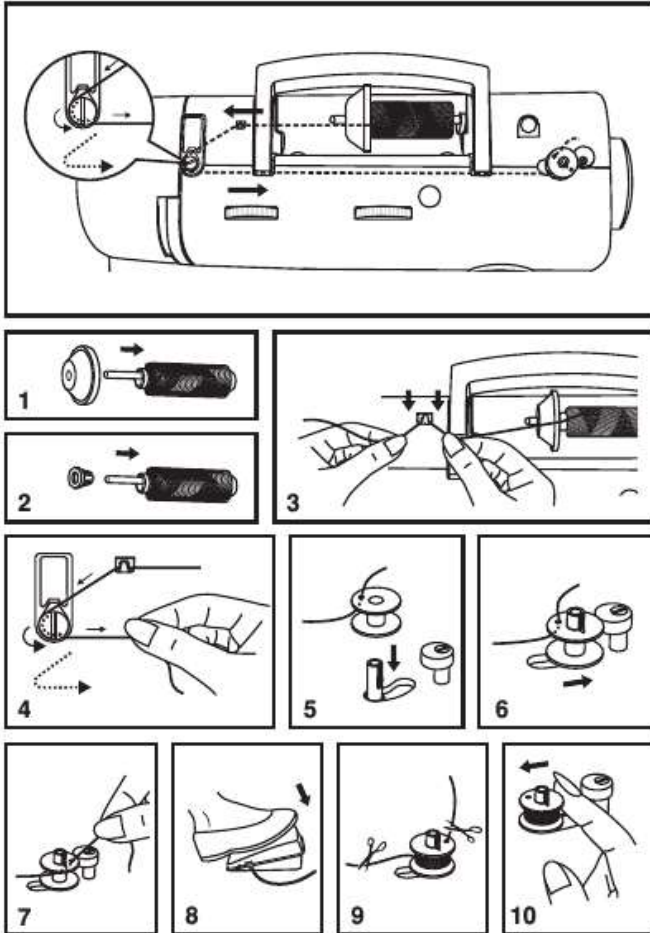

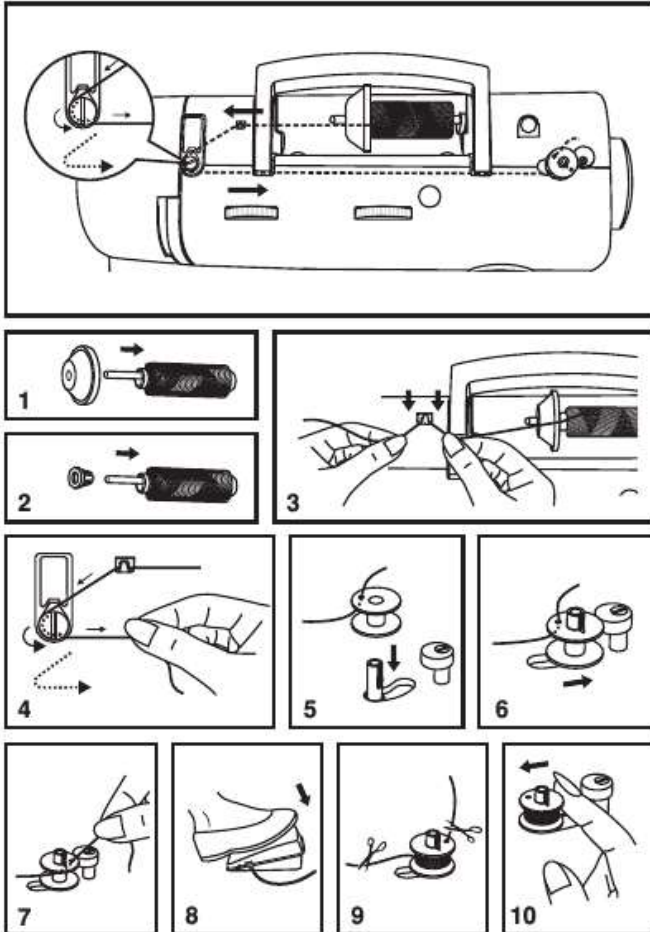

***We must come close to God***

***We need to clean up our hearts and lives***

***We need to express remorse for our sin.***

***We need to humble ourselves.***

***We must come close to God***

***James 4:6***

But he gives us more grace.  
That is why Scripture says:  
“God opposes the proud but  
gives grace to the humble.”

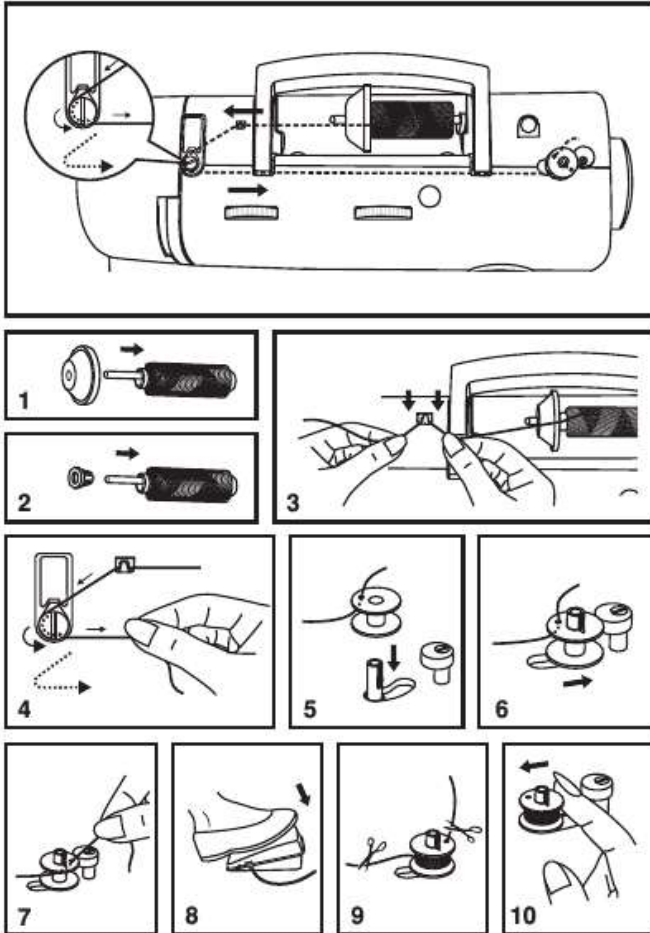



*We must humble ourselves*

**James 4:10**

Humble yourselves before the Lord, and he will lift you up.

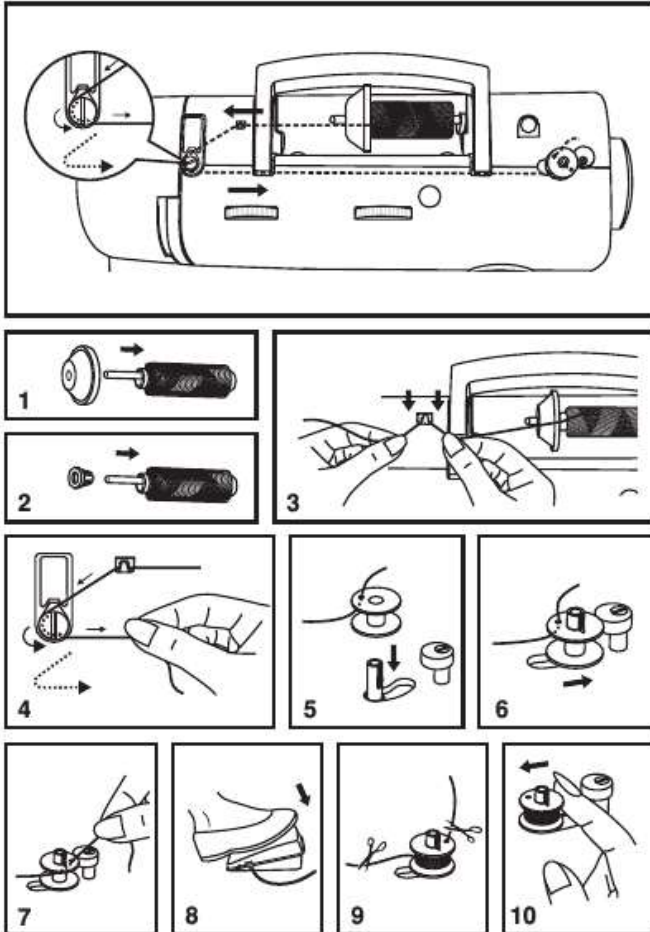

*We must humble ourselves*

**ATTENTION:**

*The more humble we are,  
the more grace we receive.  
And the more grace we  
receive, the more we  
should pass on to others.*

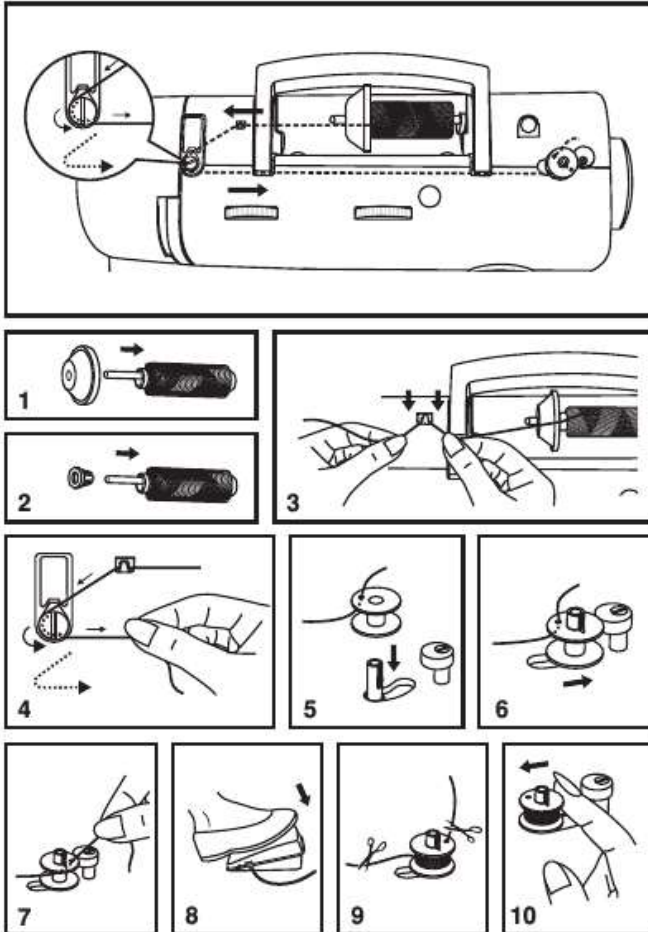

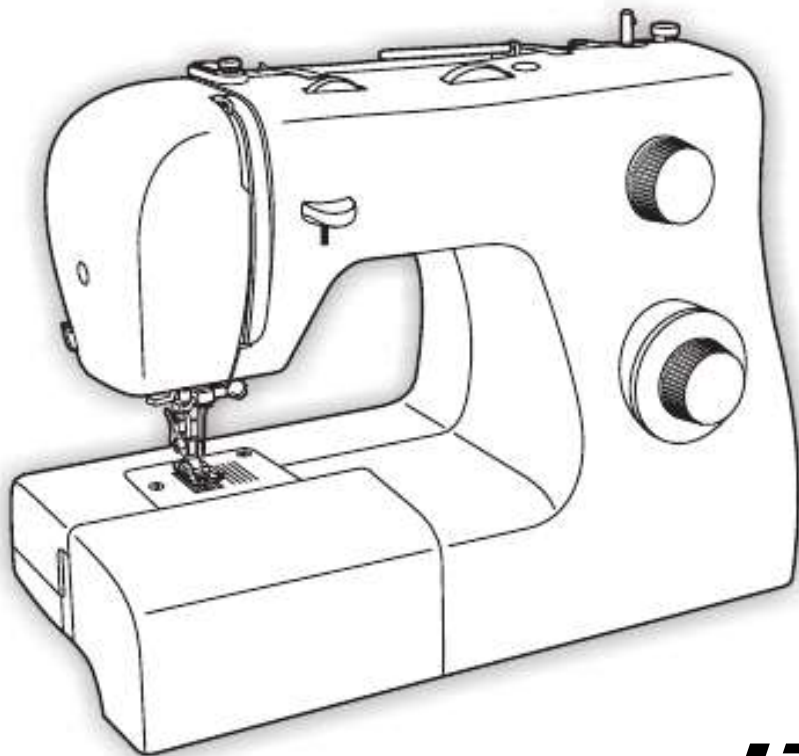

***Life Instruction Manual***

**2263** ***Manual de Instrucciones***

***Manuel d'Instruction***