

THE BOOK OF JAMES
Life Instruction Manual

2263 ***Manual de Instrucciones***

Manuel d'Instruction

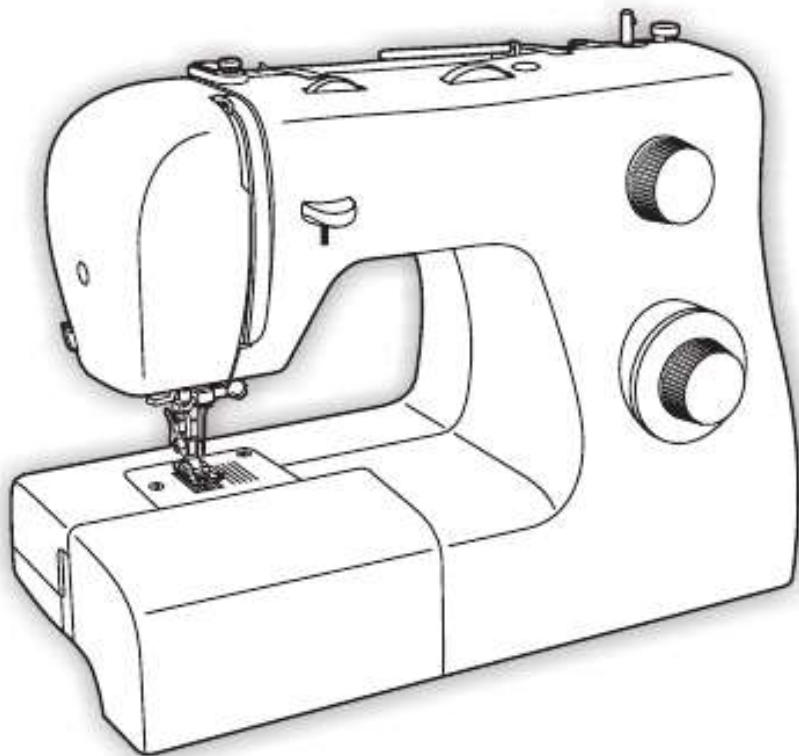

DO THE DO
James 1:21-25

2263 *Manual de Instrucciones*

Manuel d'Instruction

James 1:21-25

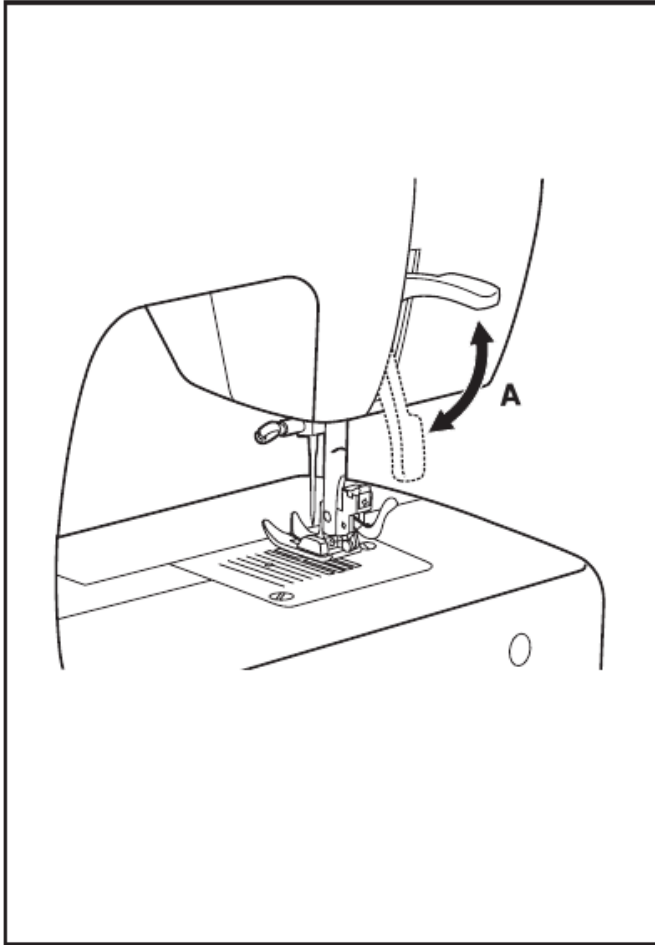

²² But don't just listen to God's word. You must do what it says. Otherwise, you are only fooling yourselves. ²³ For if you listen to the word and don't obey, it is like glancing at your face in a mirror. ²⁴ You see yourself, walk away, and forget what you look like. ²⁵ But if you look carefully into the perfect law that sets you free, and if you do what it says and don't forget what you heard, then God will bless you for doing it.

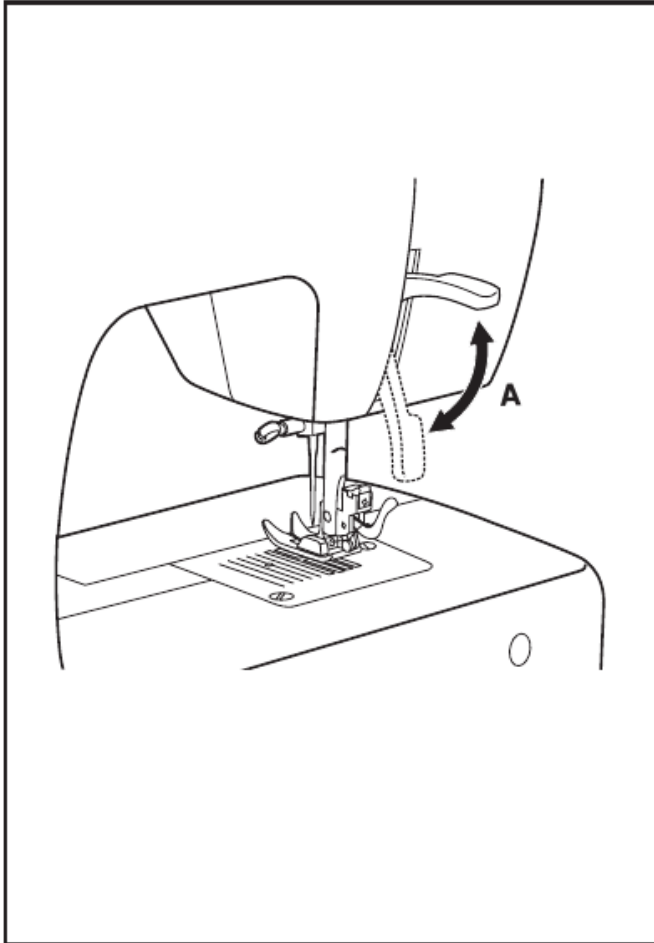

ATTENTION:
Knowledge is the accumulation of information, while wisdom is knowing what to do with that knowledge and how to apply it in real world situations and in your own life.

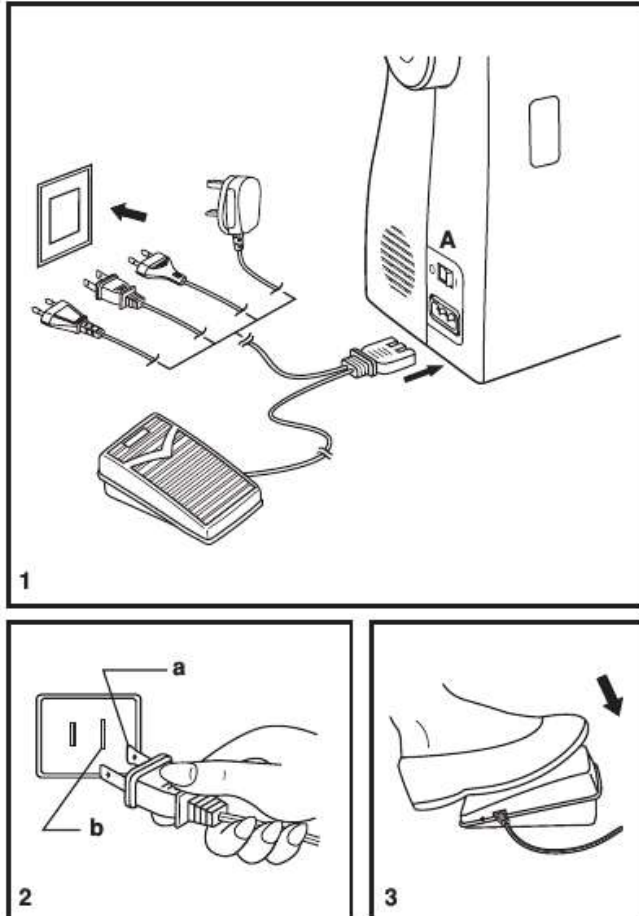

James 1:22-25

²² But don't just listen to God's word. You must do what it says. Otherwise, you are only fooling yourselves. ²³ For if you listen to the word and don't obey, it is like glancing at your face in a mirror. ²⁴ You see yourself, walk away, and forget what you look like. ²⁵ But if you look carefully into the perfect law that sets you free, and if you do what it says and don't forget what you heard, then God will bless you for doing it.

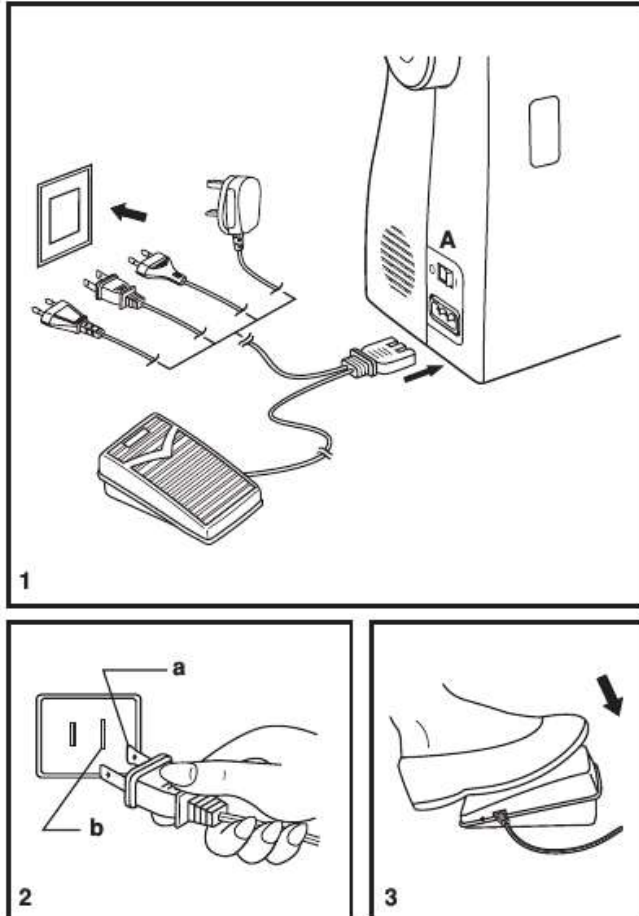

Romans 10:9-10

⁹ If you confess with your mouth that Jesus is Lord and believe in your heart that God raised him from the dead, you will be saved.

¹⁰ For it is by believing in your heart that you are made right with God, and it is by confessing with your mouth that you are saved.

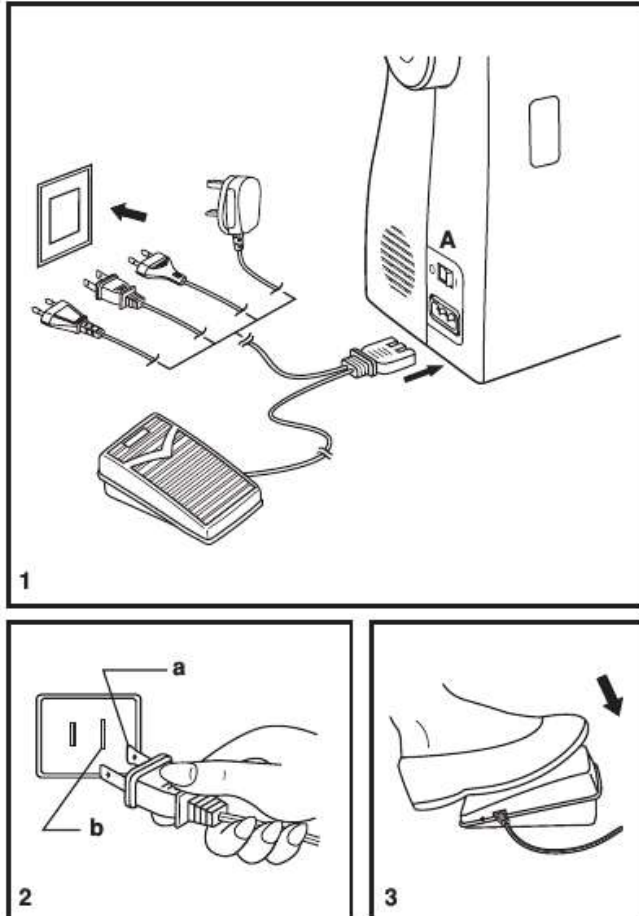

ATTENTION:
Jesus went and did,
Jesus didn't sit at home
in Capernaum and revel
in the knowledge of
who He was.

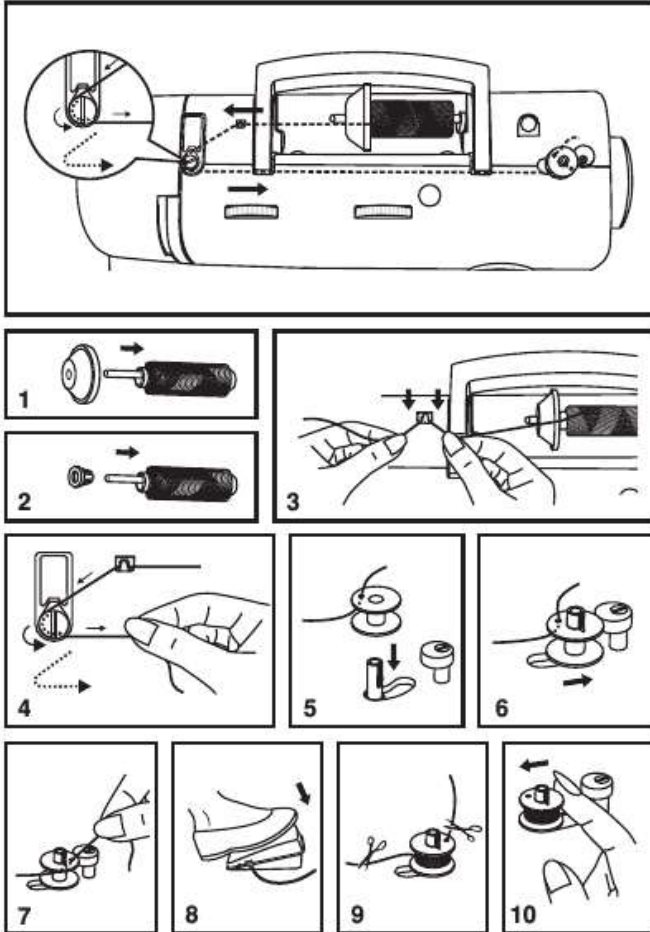

James 1:23-24

²³ For if you listen to the word and don't obey, it is like glancing at your face in a mirror. ²⁴ You see yourself, walk away, and forget what you look like.

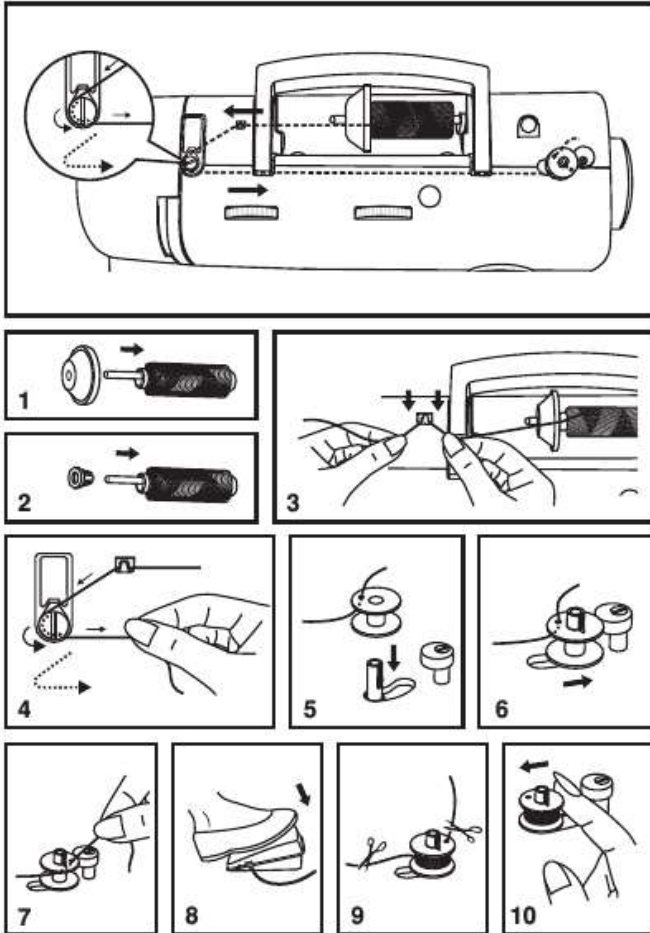

ATTENTION:
We are still prone to forgetfulness, we lose sight of who we are in God's eyes and we disconnect our hands from our heart.

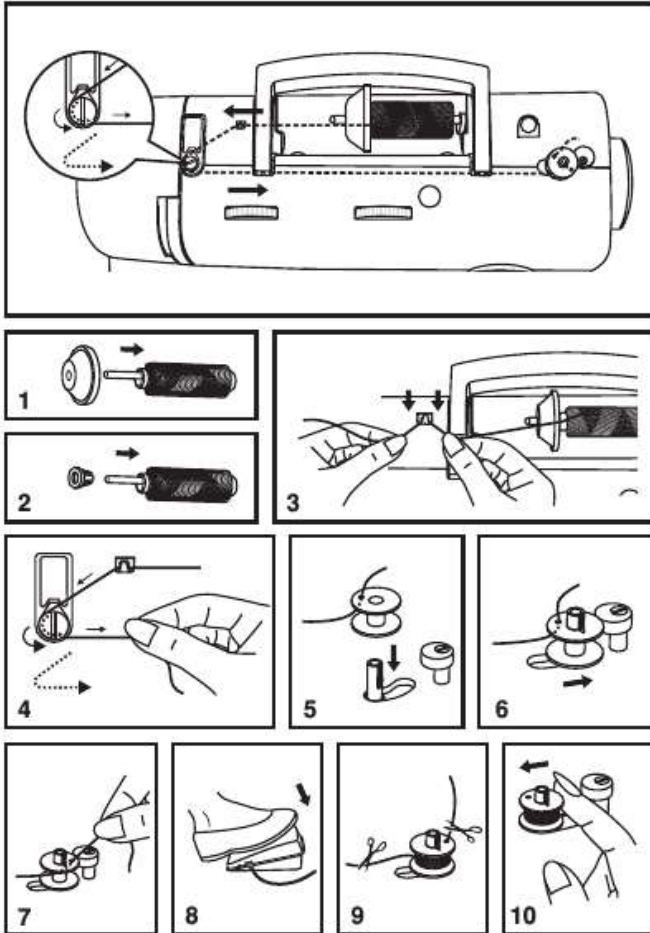

Romans 2:13

For merely listening to the law doesn't make us right with God. It is obeying the law that makes us right in his sight.

Luke 19:20-26

²⁰ “But the third servant brought back only the original amount of money and said, ‘Master, I hid your money and kept it safe.’ ²¹ I was afraid because you are a hard man to deal with, taking what isn’t yours and harvesting crops you didn’t plant.’

²² “‘You wicked servant!’ the king roared. ‘Your own words condemn you. If you knew that I’m a hard man who takes what isn’t mine and harvests crops I didn’t plant, ²³ why didn’t you deposit my money in the bank? At least I

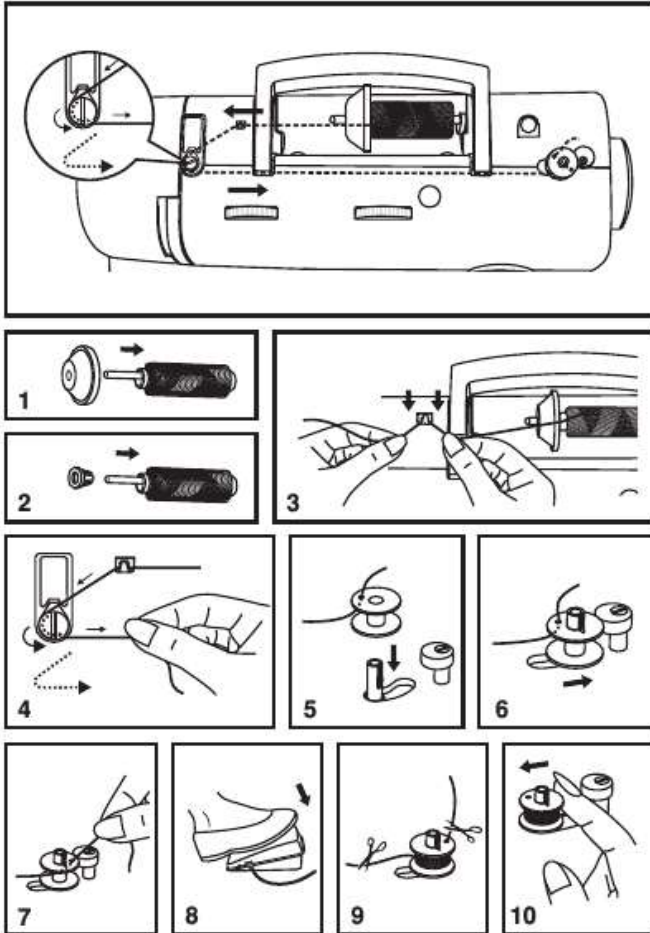

Luke 19:20-26

could have gotten some interest on it.'

²⁴ "Then, turning to the others standing nearby, the king ordered, 'Take the money from this servant, and give it to the one who has ten pounds.'

²⁵ "'But, master,' they said, 'he already has ten pounds!'

²⁶ "'Yes,' the king replied, 'and to those who use well what they are given, even more will be given. But from those who do nothing, even what little they have will be taken away.'

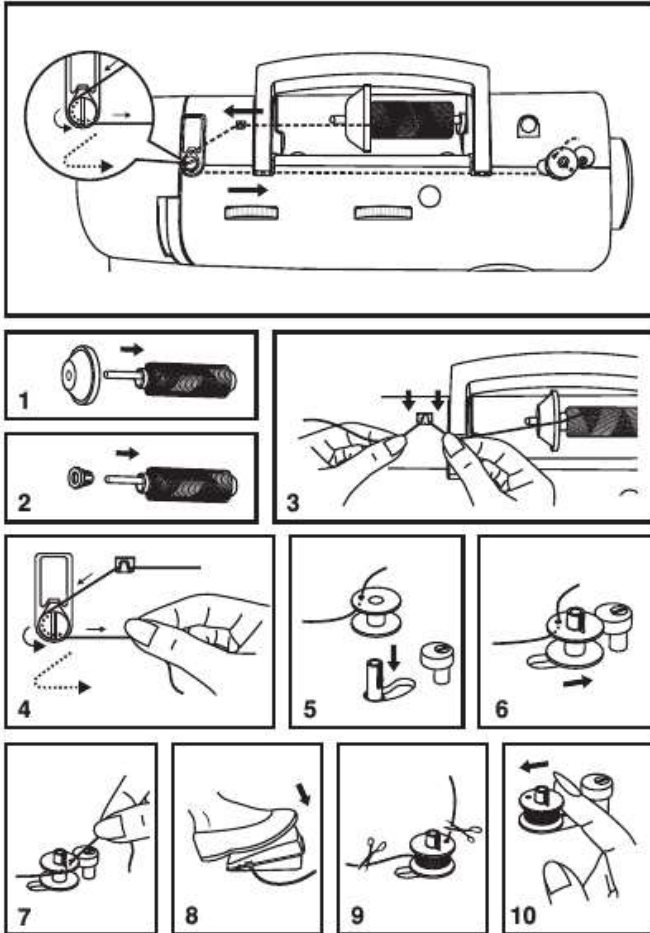

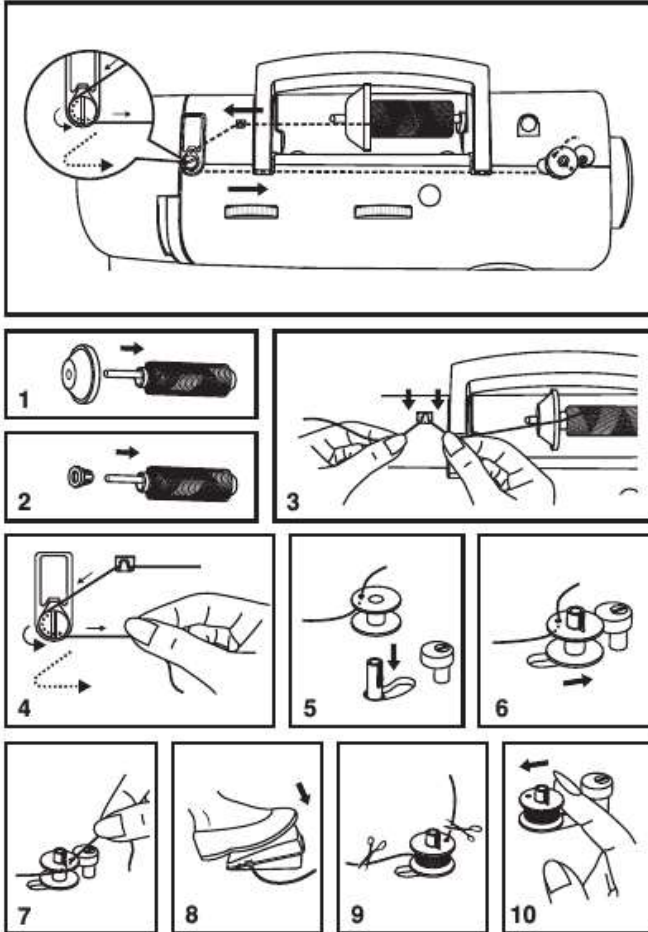

Proverbs 17:27-28

A truly wise person uses few words; a person with understanding is even-tempered. ²⁸ Even fools are thought wise when they keep silent; with their mouths shut, they seem intelligent.

3

FINISH THE CIRCUIT

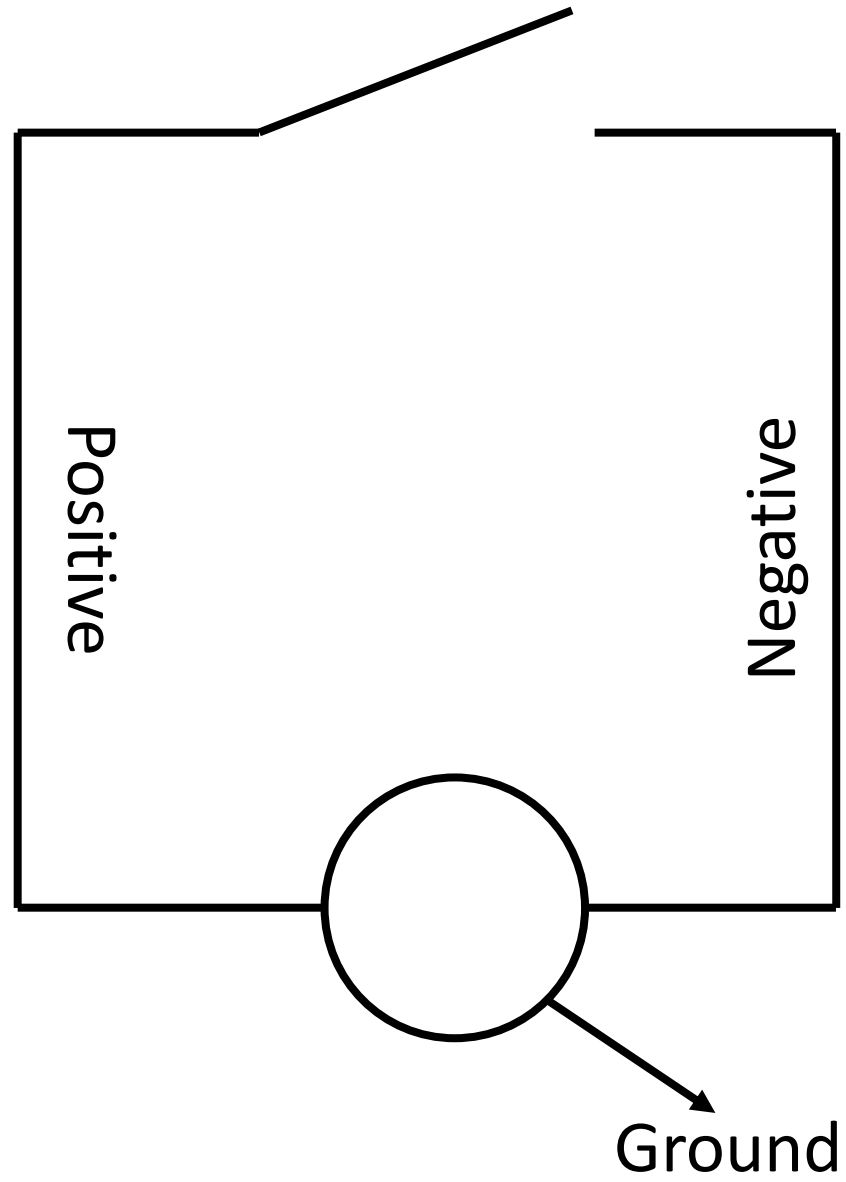
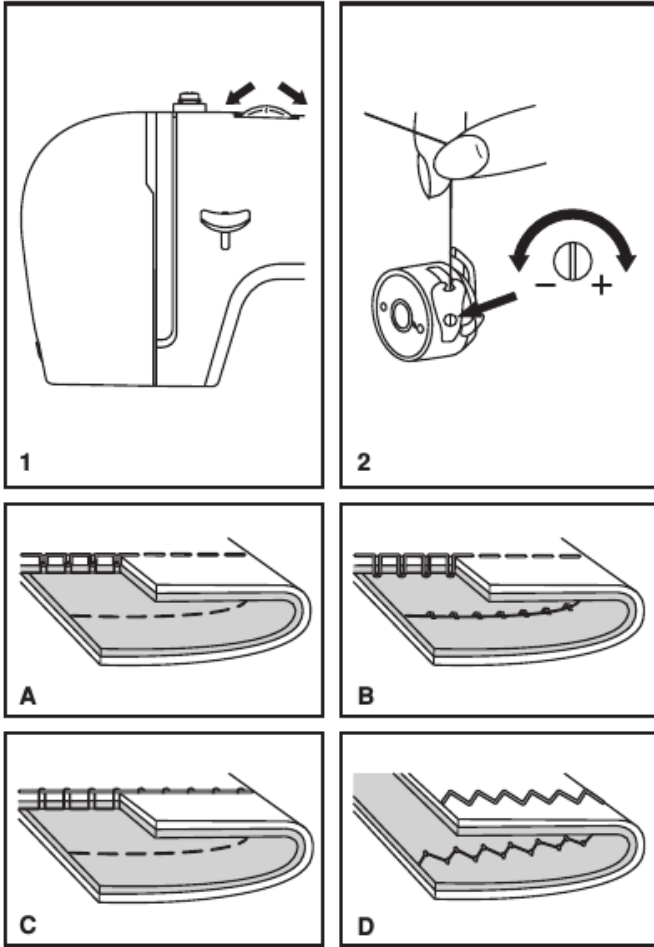

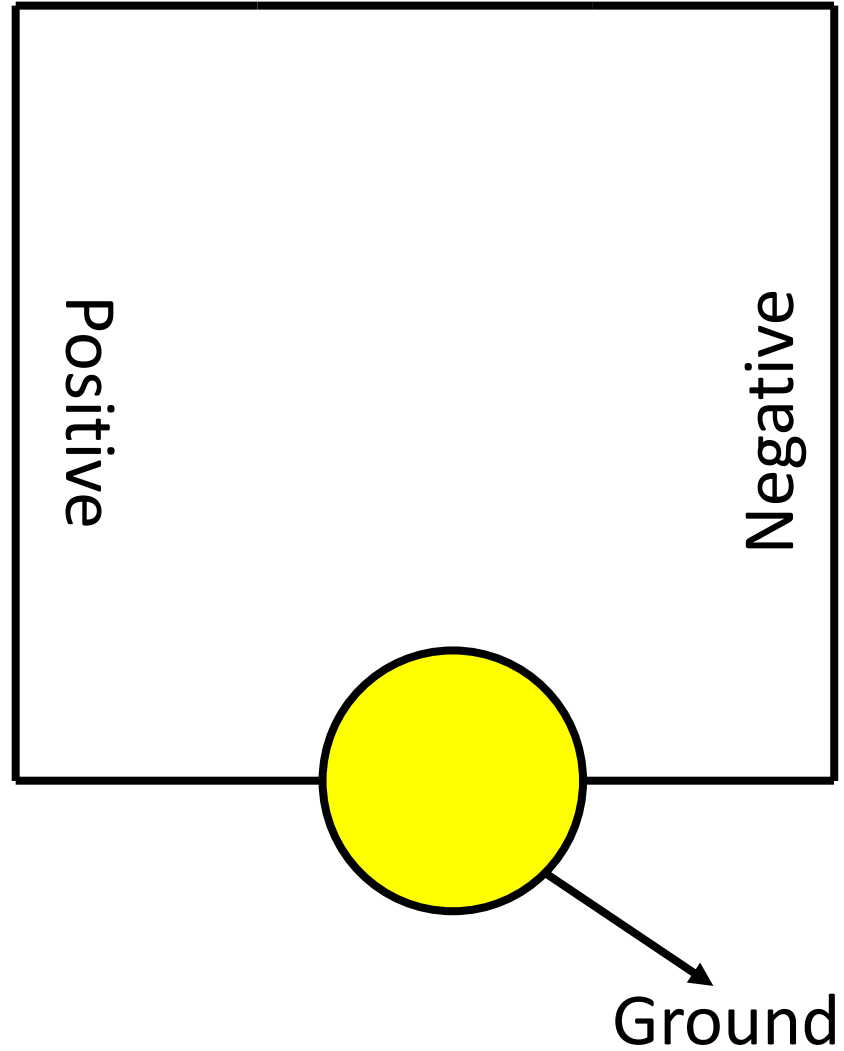
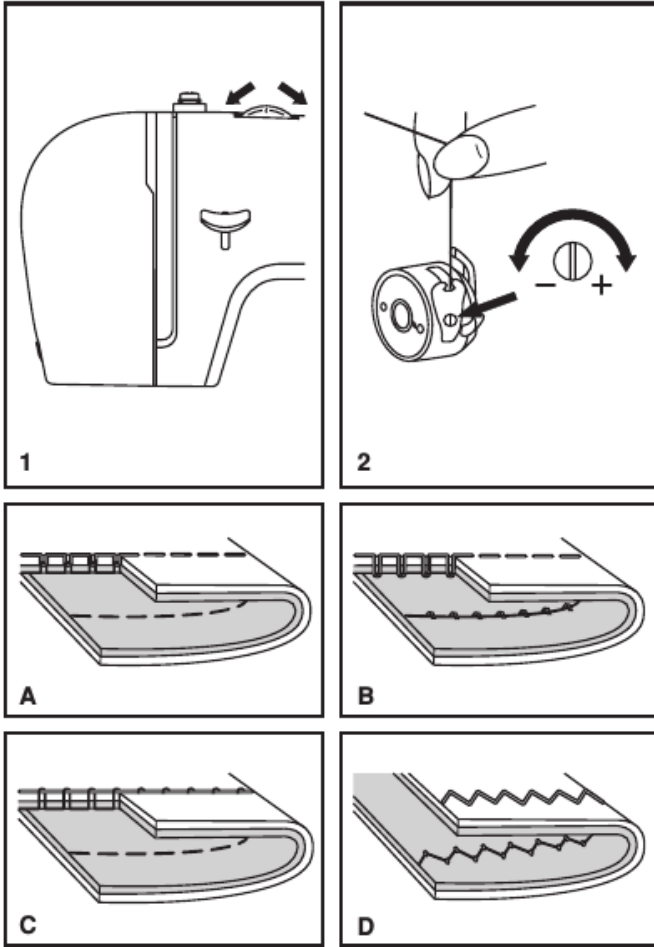

3

FINISH THE CIRCUIT

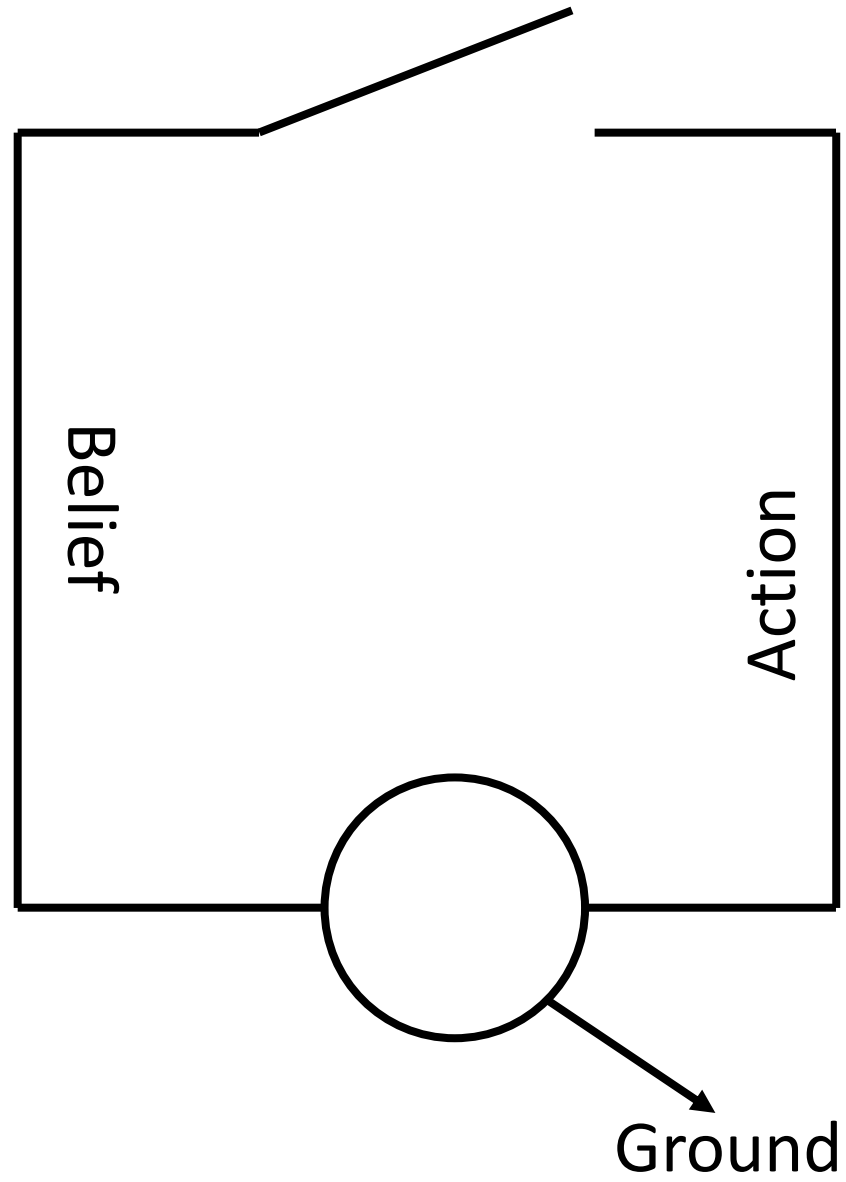
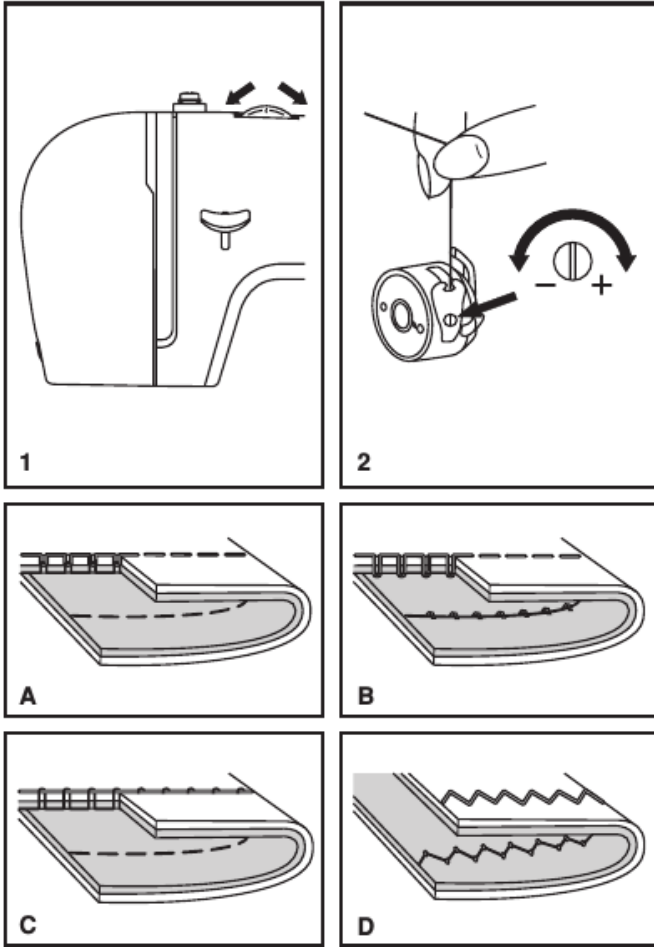

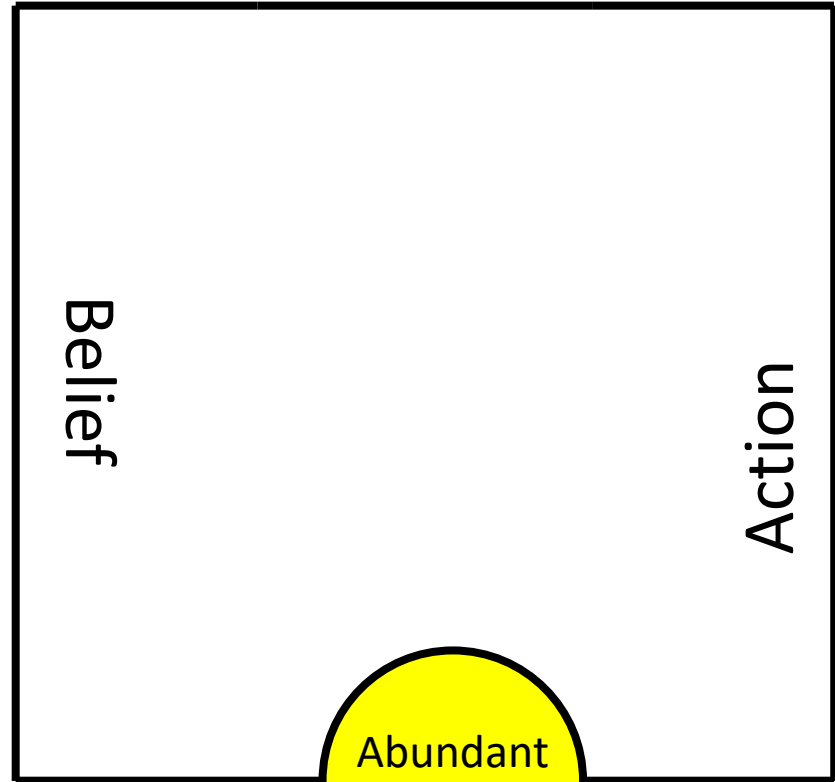
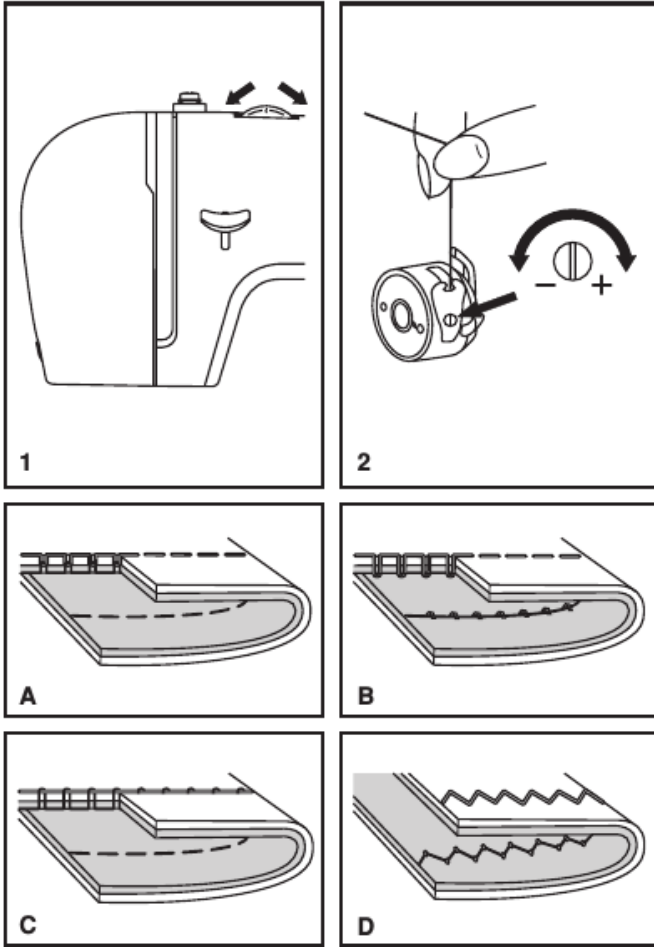

Ground

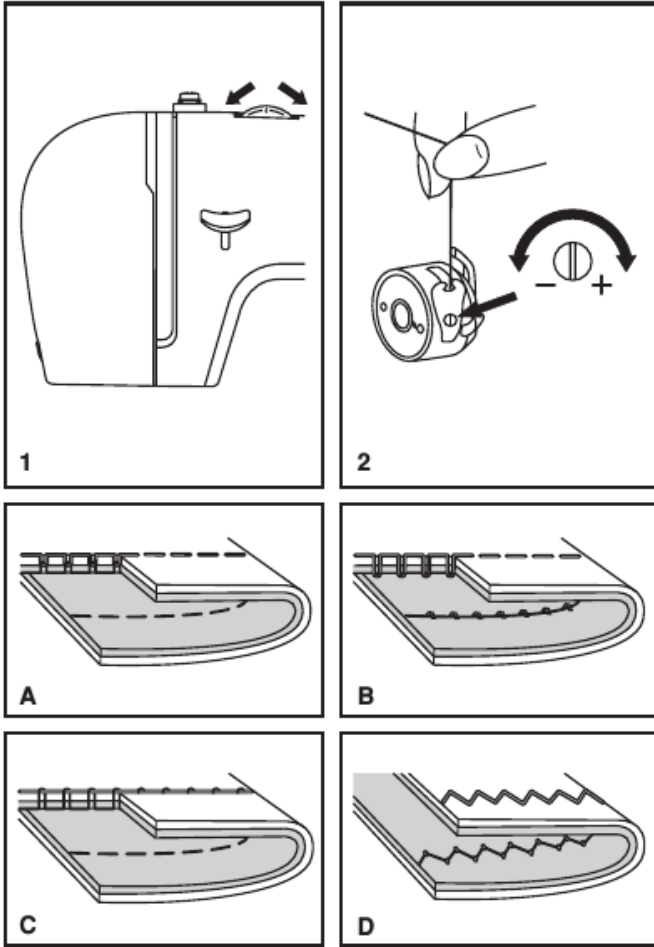

ATTENTION:
*We must have the +
side of belief, the – side
of action and we must
be grounded in Christ.*

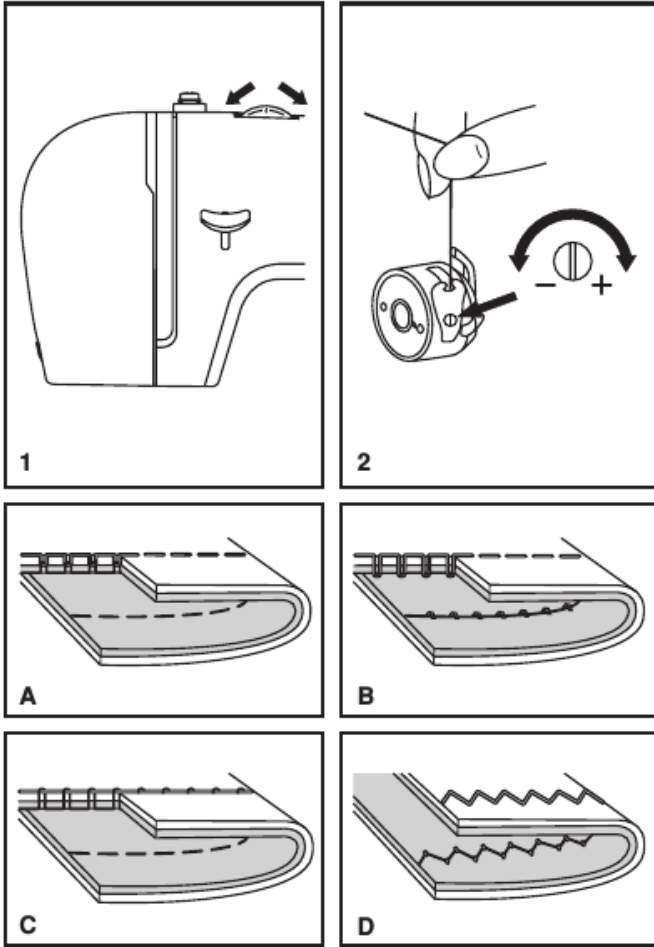

ATTENTION:
He blessed and healed those who had the truth of those words become real to them.

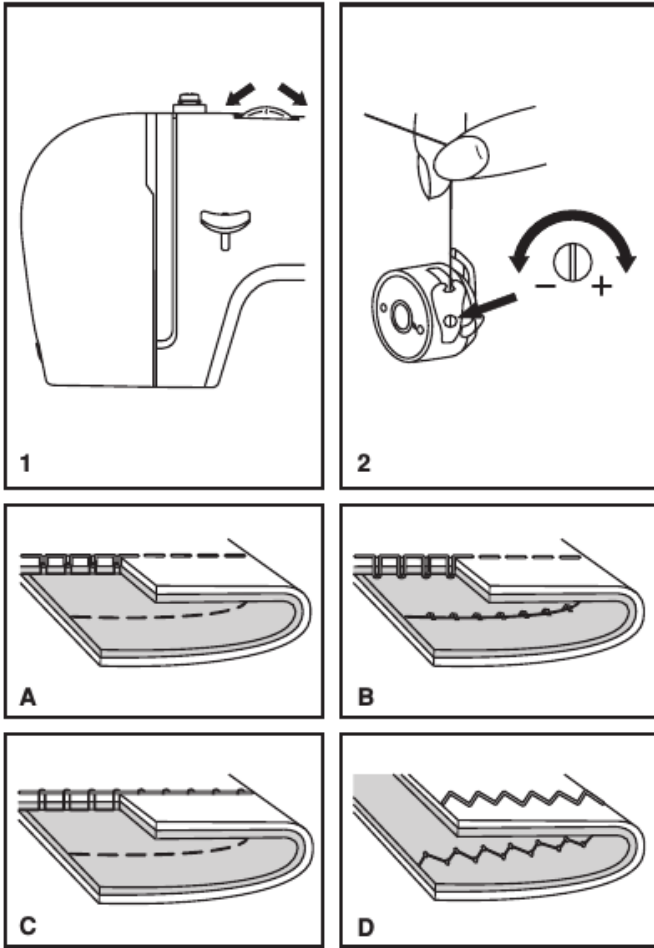

Matthew 9:27

After Jesus left the girl's home, two blind men followed along behind him, shouting, "Son of David, have mercy on us!"

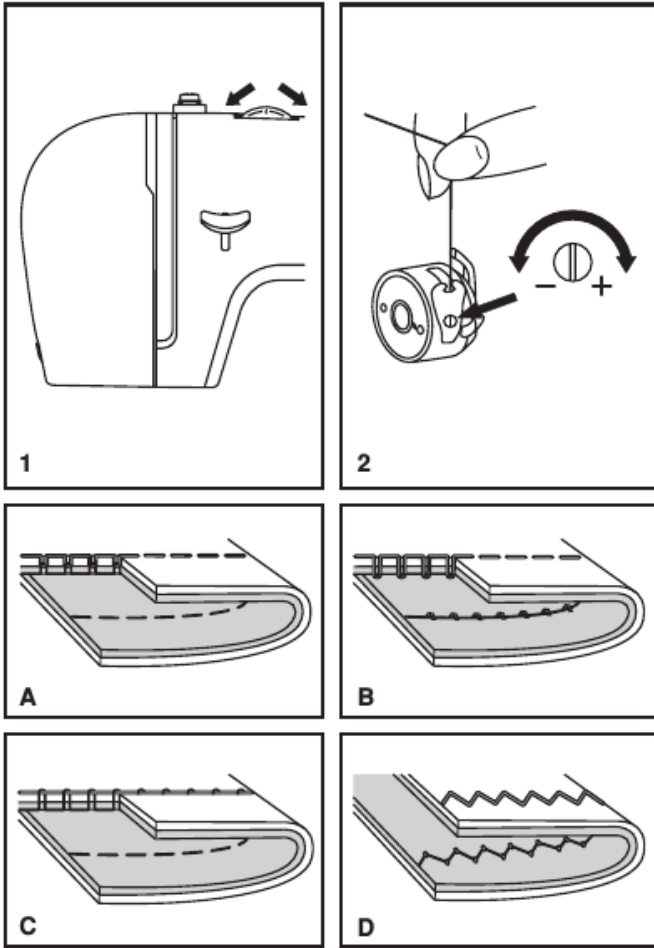

Matthew 15:22

A Gentile woman who lived there came to him, pleading, “Have mercy on me, O Lord, Son of David! For my daughter is possessed by a demon that torments her severely.”

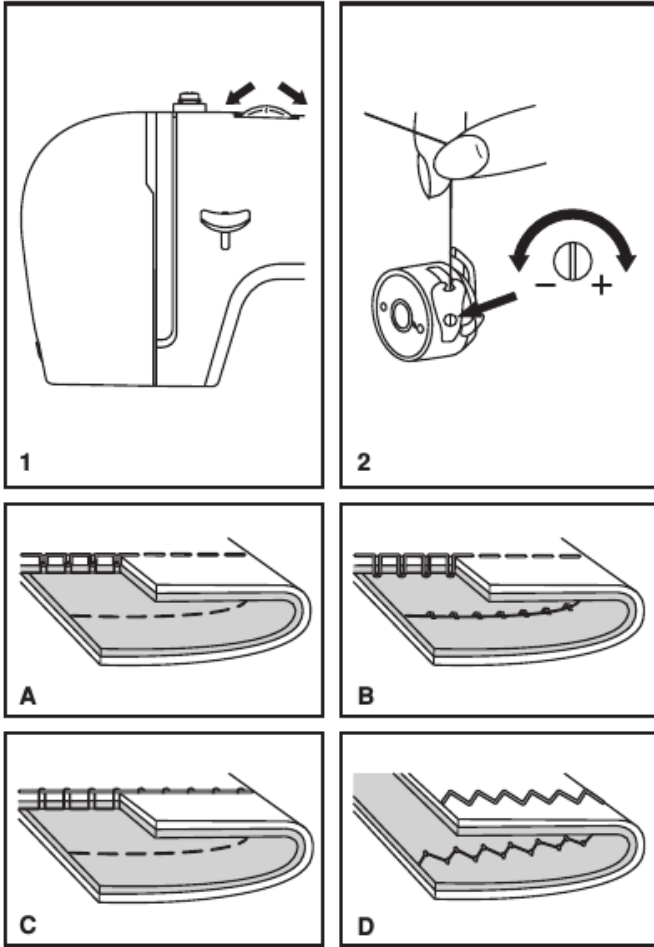

Matthew 20:30

Two blind men were sitting beside the road. When they heard that Jesus was coming that way, they began shouting, “Lord, Son of David, have mercy on us!”

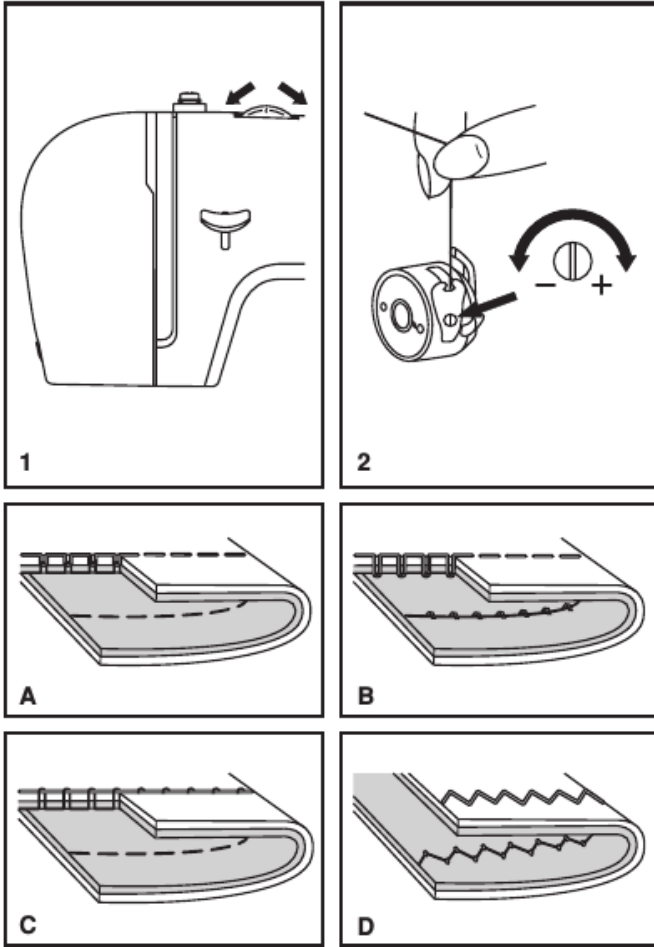

ATTENTION:
The disciples where expected to live out what Jesus preached when He was gone.

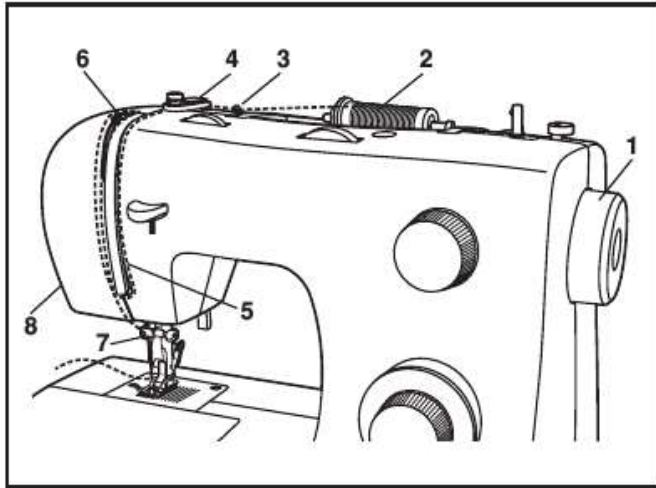

Abraham believed God and moved away from Haran

Joshua and the people believed God for victory and marched around Jericho

David believed that God appointed Him as the next king so he left the farm

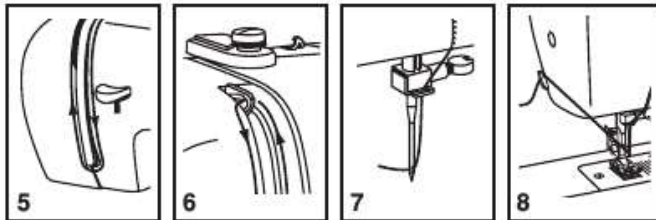
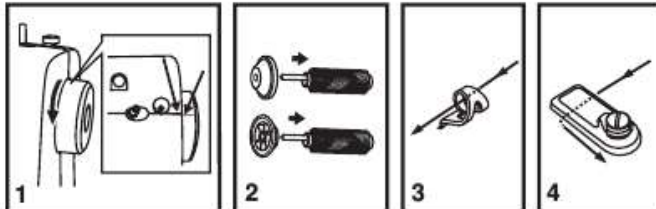

2 Kings 13:15-19

¹⁵ Elisha told him, “Get a bow and some arrows.” And the king did as he was told. ¹⁶ Elisha told him, “Put your hand on the bow,” and Elisha laid his own hands on the king’s hands.

¹⁷ Then he commanded, “Open that eastern window,” and he opened it. Then he said, “Shoot!” So he shot an arrow. Elisha proclaimed, “This is the Lord’s arrow, an arrow of victory over Aram, for you will completely conquer the Arameans at Aphek.”

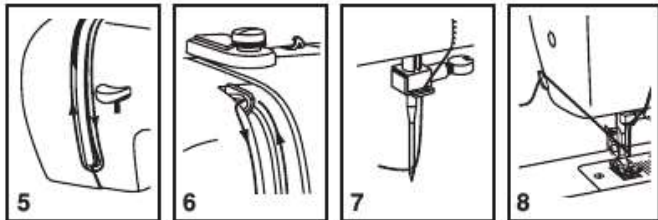
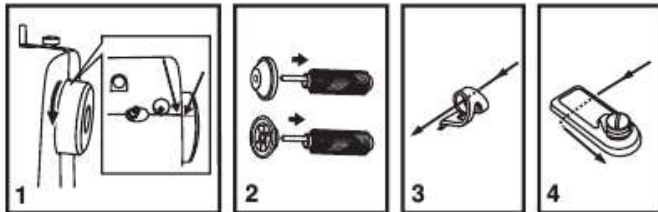
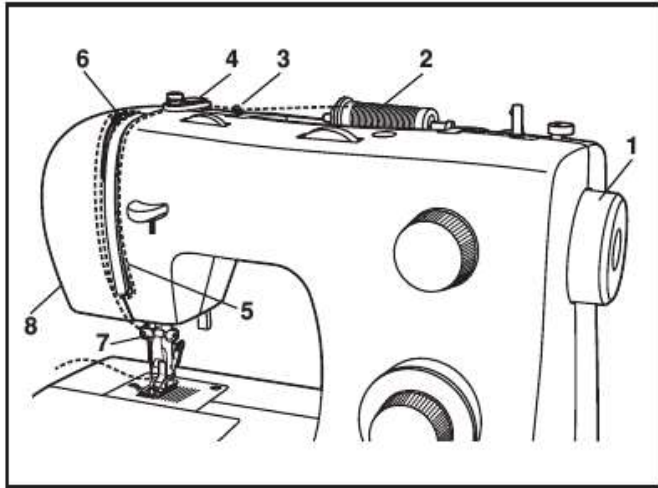

2 Kings 13:15-19

¹⁸ Then he said, “Now pick up the other arrows and strike them against the ground.” So the king picked them up and struck the ground three times. ¹⁹ But the man of God was angry with him. “You should have struck the ground five or six times!” he exclaimed. “Then you would have beaten Aram until it was entirely destroyed. Now you will be victorious only three times.”

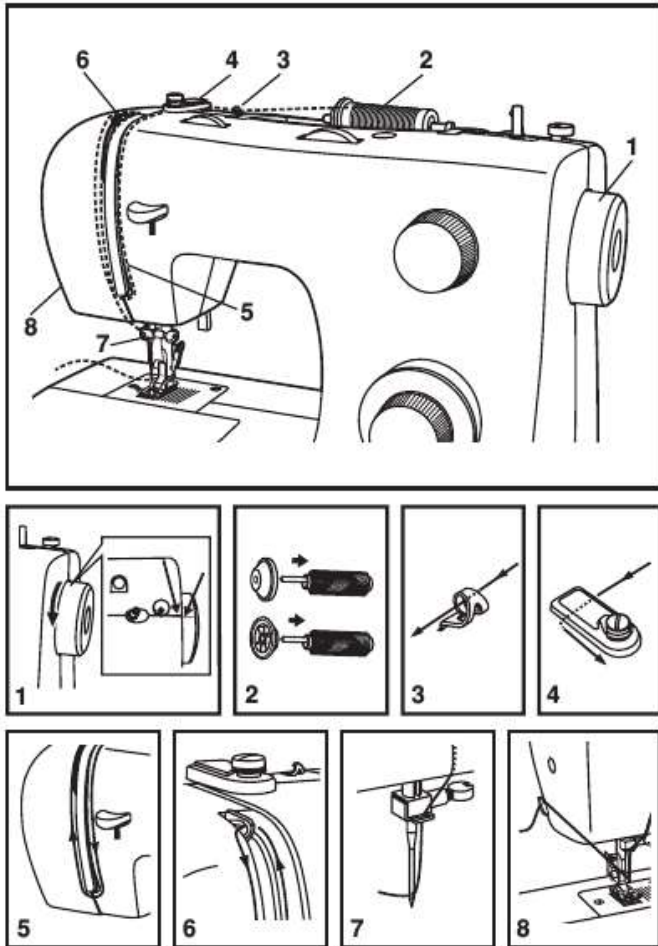

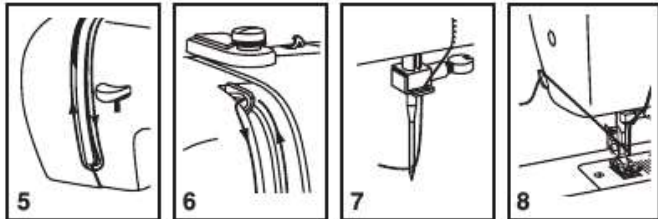
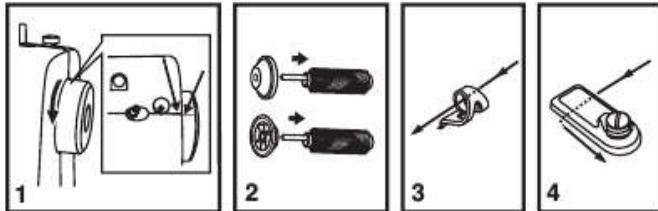
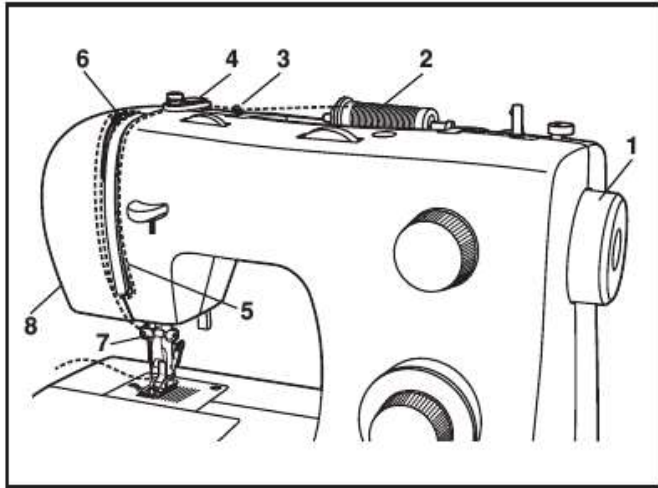

There was a disconnect in the king between his belief, his action and his relationship with God.

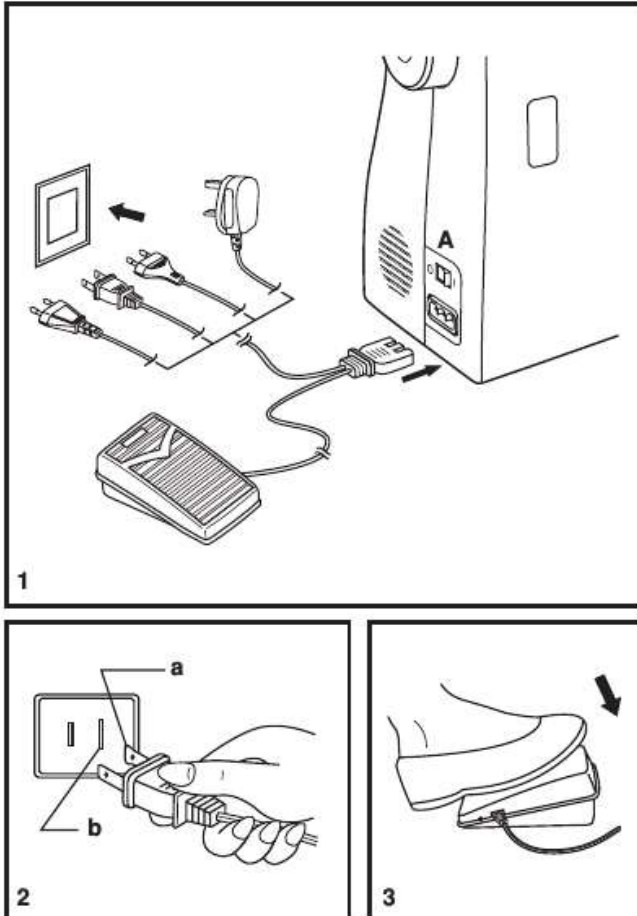

John 15:12-14

¹² This is my commandment: Love each other in the same way I have loved you. ¹³

There is no greater love than to lay down one's life for one's friends. ¹⁴ You are my friends if you do what I command.

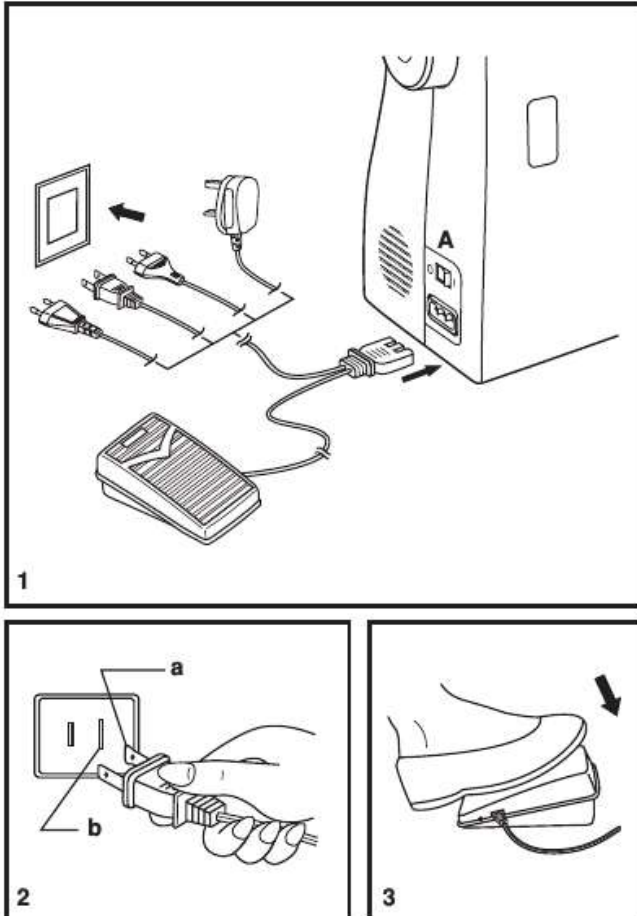

Our actions confirm our beliefs, what we say and do is rooted in our heart and in what we really believe about God, ourselves and the world at large.

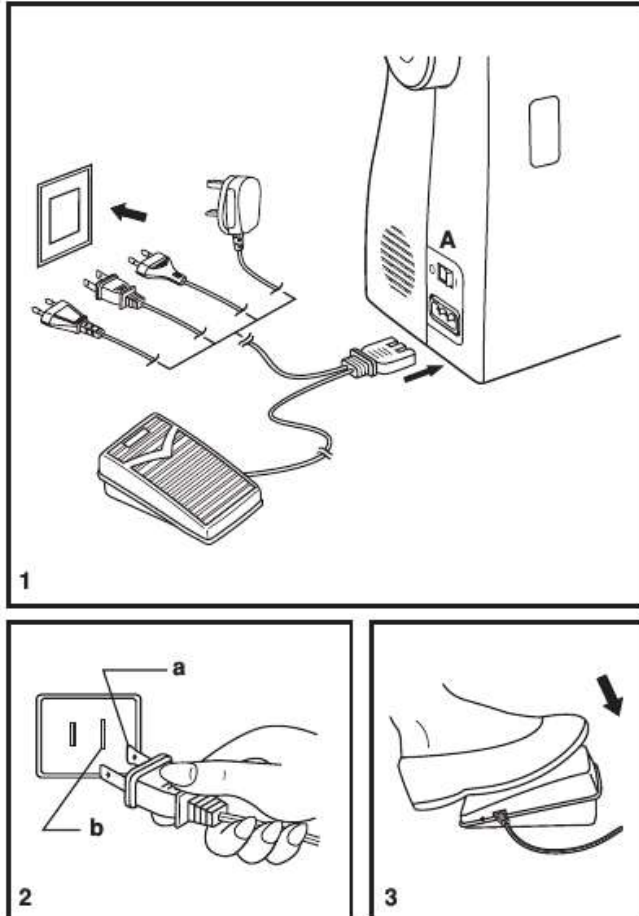

1 John 2:3-6

³ And we can be sure that we know him if we obey his commandments. ⁴ If someone claims, “I know God,” but doesn’t obey God’s commandments, that person is a liar and is not living in the truth. ⁵ But those who obey God’s word truly show how completely they love him. That is how we know we are living in him. ⁶ Those who say they live in God should live their lives as Jesus did.

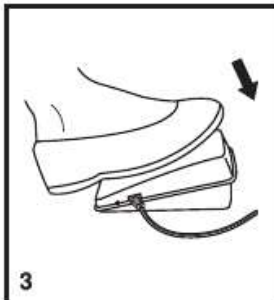
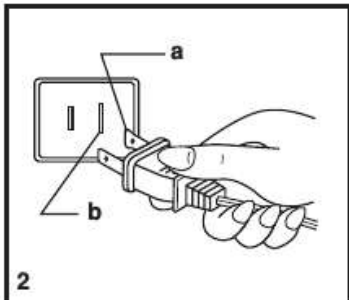
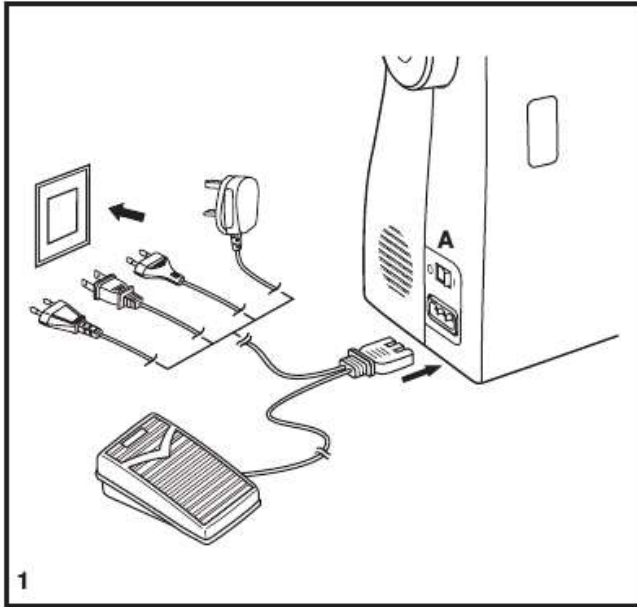

I can't actually love Jesus if I don't follow Him and His words.

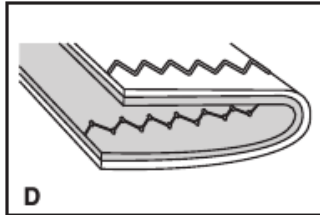
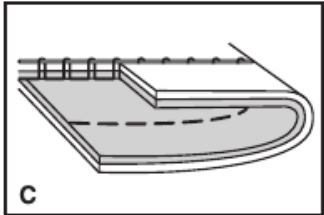
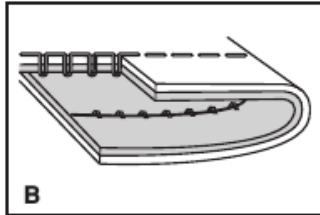
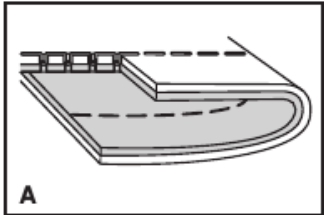
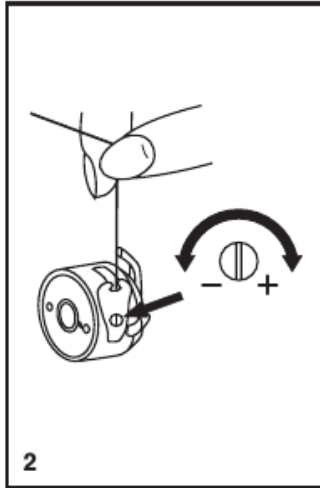
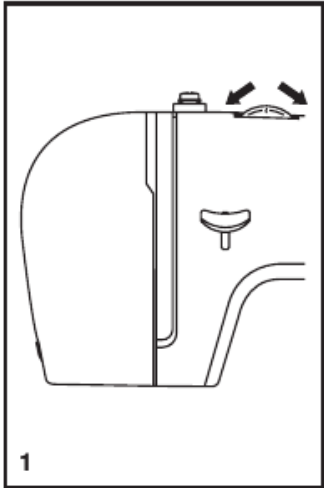

What will I do with this knowledge?

What will I pray about?

What will I change?

What action will I take?

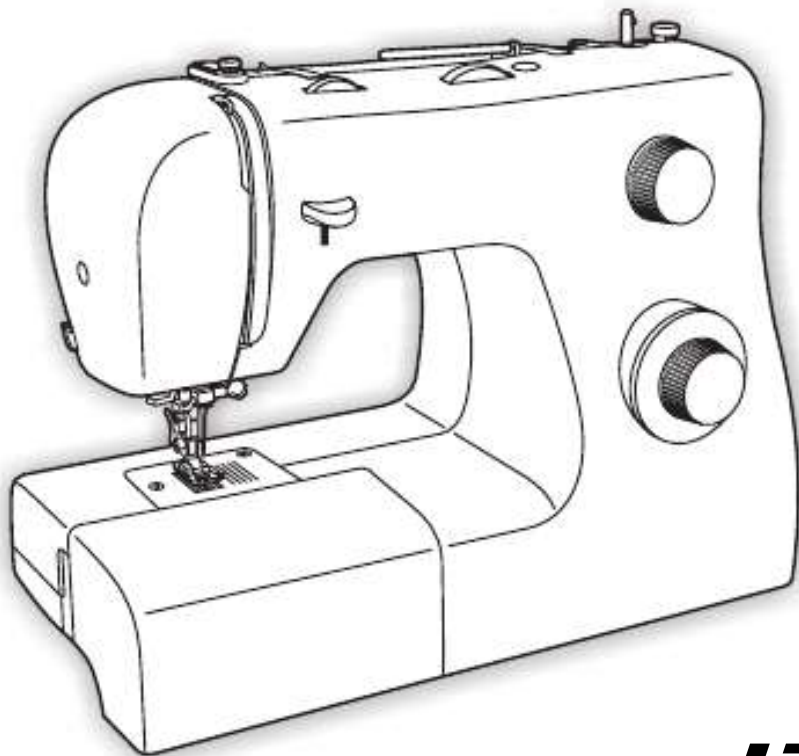

Life Instruction Manual

2263 Manual de Instrucciones

Manuel d'Instruction